

Application of S-transform for fault location in combined overhead line and cable distribution networks

Hamed Hasanvand¹, Soodabeh Soleymani², Behnam Feizifar³, Bashir Bakhshideh Zad⁴

Received: 2013/11/2

Accepted: 2014/5/12

Abstract

This paper illustrates the application of S-transform and continuous wavelet transform (CWT) for fault location in combined overhead line and cable distribution networks. The high frequency transient signals originated by faults are analyzed using S-transform and CWT. The S-transform is found to be applicable in transient based fault location in distribution networks. This technique is an expansion of wavelet transform method and is based on a moving and scalable localizing Gaussian window. Taking into account this fact that the signal energy of faults has high amplitude around certain frequencies, the fault location can be identified considering the relationship between these frequencies and so-called path characteristic frequencies related to the fault traveling waves. The transient voltage signal energy is calculated using S-Transform and CWT. In order to demonstrate the effectiveness of the proposed method, the distribution networks with only overhead lines, as well as a combined system (consisting of the overhead lines and underground cables) have been studied. The IEEE 34-bus test distribution network is simulated in EMTP-RV software and the relevant S-transform and CWT analyses are carried out in MATLAB coding environment.

Keywords: Distribution networks, fault location, S-transform, wavelet transform, characteristic frequency.

1. Introduction

During the recent years, the reliability of distribution networks has become an important issue. This problem is related to the number of faults and the time of interruption and restoration [1]. To make the distribution networks more reliable, it is necessary to find the exact fault location. Generally, two major

techniques have been used in the literatures for fault location. These methods can be classified in two categories. 1- Impedance measurement [2-5] and 2- Transient signal analysis [6-13]. The former method based on the distance relay concept employs voltage and current signal at the fundamental frequency in order to calculate the fault impedance. The later one uses the analysis of travelling waves originated by faults. In this technique, some measuring points should be determined. The measuring devices are usually installed on the secondary side of distribution transformers. The fault type and impedance do not affect this method [10]. Among many different Time-Frequency Representations (TFRs)⁵ used for signal processing and certain feature extraction, the Continuous Wavelet Transform (CWT)⁶ is a predominant technique to analyze the transient signals in distribution networks (e.g. [11,13]). Also, the time-frequency wavelet decompositions of voltage transients originated by fault traveling waves have been applied in distribution networks. The main reason to use the simultaneous time-frequency method instead of using sole-frequency techniques is to improve the identification accuracy of frequencies associated to the path characteristic frequencies [9]. It is worth mentioning that some efforts have been recently directed to improve the accuracy of CWT recently. The S-transform [14], is an extension to the ideas of wavelet transform, and is based on a moving and scalable localizing Gaussian window with characteristics superior to other transforms. It is able to be converted from time domain to 2-dimensional frequency domain and then to Fourier frequency domain easily. The S-transform technique has been used for fault location in transmission lines. It is employed to detect the arrival time of travelling waves to line terminals [15]. The S-transform has been also used along with neural network where the spectral energy feature space and multi-layer perceptron are used [16]. In this paper, it is aimed to record and analyze the transient voltage waveform of the transformer low voltage terminals feeding the distribution network using S-transform. The S-transform identifies the characteristic frequencies associated to the faulted branch and to the fault location.

2. Overview of S-transform

As mentioned before, the windowing function of S-transform is not constant and varies by frequency. Using this function, the accuracy of transformation can be improved. Suppose that $h[kT]$, $k = 0, 1, \dots, N-1$ points to a discrete time series corresponding to $h(t)$ with a time sampling interval of T . The discrete Fourier transform of $h[kT]$ is acquired as;

1 . Department of Electrical Engineering, Science and Research Branch, Islamic Azad University, Tehran, Iran

2 . Department of Electrical Engineering, Science and Research Branch, Islamic Azad University, Tehran, Iran

3 . Istanbul Technical University (ITU), Turkey

4 . University of Mons, Belgium

⁵ Time Frequency Representations

⁶ Continues Wavelet Transform

$$H\left[\frac{n}{NT}\right] = \frac{1}{N} \sum_{k=0}^{N-1} h[kT] e^{\frac{i2\pi nk}{N}} \quad (1)$$

where $n = 0, 1, \dots, N-1$. Using (1), S-transform of a discrete time series $h[kT]$ is calculated as follow;

$$S\left[jT, \frac{n}{NT}\right] = \sum_{m=0}^{N-1} H\left[\frac{m+n}{NT}\right] G(m, n) e^{\frac{i2\pi mj}{N}} \quad (2)$$

Gaussian window function is expressed as;

$$G(m, n) = e^{-\frac{2p^2 m^2}{n^2}} \quad (3)$$

where $j = m = n = 0, 1, \dots, N-1$; N is total number of samples. If $n = 0$ then S-transform is;

$$S[jT, 0] = \frac{1}{N} \sum_{m=0}^{N-1} h\left[\frac{m}{NT}\right] \quad (4)$$

3. Fault location principles

Since the fault transient signals are time-variant inherently, the traditional signal analysis methods such as Fast Fourier Transform (FFT)¹ are inadequate to extract frequency characteristic of these signals. Despite the traditional signal analysis methods, S-transform is well-suited for time-frequency analysis of non-stationary signals. In a radial distribution network configuration, specific number of paths can be monitored at a measuring point. These voltage measuring points are usually located in the secondary side of the power transformer feeding the entire network. Number of paths is closely related to the number of network laterals or feeder lateral conjunctions. Therefore, S-transform method can be used to identify the characteristic frequencies related to the mentioned paths. In this paper, in order to evaluate the effectiveness of the proposed method, the IEEE 34-bus test system is simulated. As shown in Figure 1, in order to explain the principle of fault location, a section of this standard test system is selected.

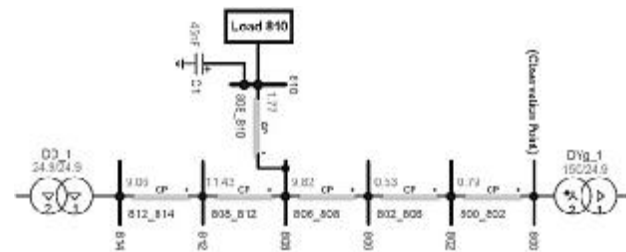

Figure 1. A section of the IEEE 34-bus test system modeled in EMTP-RV considering a fault between two neighbor buses [17]

As mentioned below, four paths can be observed in Figure 1 by considering the fact that each path can be associated to a number of characteristic frequencies (one for each of the traveling wave propagation modes) [18,19].

- 1- Between bus 800 and fault location;
- 2- Between buses 800 and 808;
- 3- Between buses 800 and 810;
- 4- Between bus 810 and fault location (not related to measuring point).

Frequency of mode i through path p is defined as [6];

$$f_{p,i} = \frac{v_i}{n_p L_p} \quad (5)$$

where v_i is the i th propagation mode travelling wave velocity, L_p is p th path length and n_p ($\in N$) is the number of times required for a travelling wave moving toward and backward through path p to get again the same polarity. As known, the reflection coefficient depends on different ends of the network;

- Power transformer connections can be considered as open circuits and therefore, the reflection coefficient is near to +1,
- Junction between more than two lines makes reflection coefficient negative,
- Since the fault impedance is lower than the line surge impedance at fault location, thus the reflection coefficient is close to -1.

It must be noted that value of n_p is defined based on the sign (polarity) of reflection coefficients between path extremities. In fact, if the reflection coefficients have the same sign, n_p becomes equal to 2, and in case of opposite sign, it equals to 4. The propagation velocities of underground cables and overhead lines vary because the characteristics of these environments are not the same. Therefore an equivalent frequency for combined distribution networks must be calculated [12]. The equivalent frequency can be formulated as below (based on Eq. 5);

$$\frac{1}{f_{eq,p,i}} = \frac{1}{f_{L1,p,i}} + \frac{1}{f_{L2,p,i}} + \mathbf{L} + \frac{1}{f_{Lm,p,i}} + \frac{1}{f_{C1,p,i}} + \frac{1}{f_{C2,p,i}} + \mathbf{L} + \frac{1}{f_{Cn,p,i}} \quad (6)$$

where m and n are the number of overhead lines and underground cables respectively.

¹ Fast Fourier Transform

4. Fault transient signal analysis

As mentioned before, S-transform as a transient signal analysis tool is applied to analyze high frequency transient signals produced by faults. Using Eq.2, the S-matrix is constructed and in the next step the energy of fault transient signal can be expressed as follow,

$$E_{S-trans} \left(jT, \frac{n}{NT} \right) = \sum_{j=0}^{N-1} \left(S \left[jT, \frac{n}{NT} \right] \right)^2 \quad (7)$$

As known, the energy spectrum of the fault transient signal has high amplitude around the path characteristic frequencies. On the other side, using the theoretical method allows obtaining these mentioned frequencies. These 2 sets of frequencies must have logical relationship due to their originating sources. The fault location is attained using this comparative information.

5. Results

5.1. System with overhead lines

The IEEE 34-bus distribution network is simulated in EMTP-RV software to show the effectiveness of the proposed method for fault location. A 3-phase balanced fault is occurred at bus 812. As mentioned, measuring device is installed at the medium voltage side of the feeding transformer (bus 800). It is clear that 3 routes terminate in bus 800 and other side of paths correspond to the buses 812 (path 1), 808 (path 2) and 810 (path 3). Figure 2, section (a), shows transient high frequency voltage signal of propagation mode 1 resulting from fault at bus 812. The second section (b) represents its S-transform energy signal. The relevant results are summarized in Table 1.

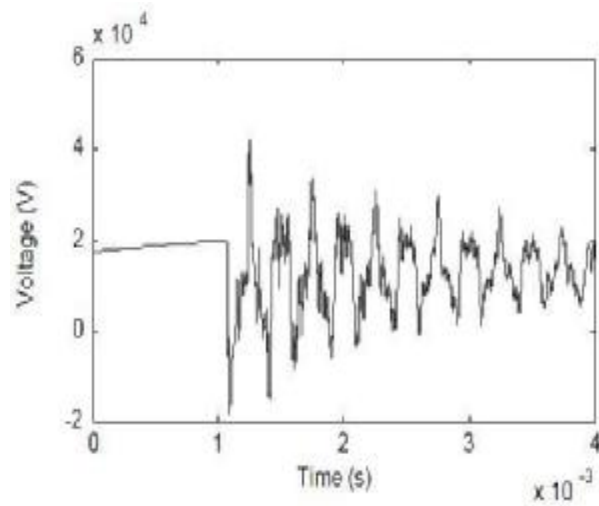

(a). Transient voltage signal

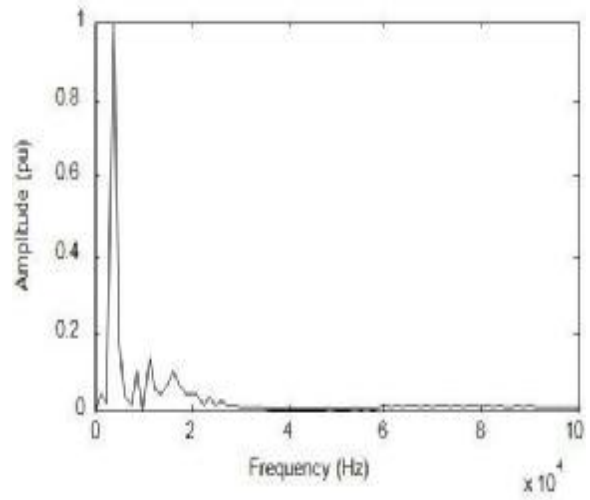

(b) S-transform signal energy

Figure 2. Transient voltage signal and relevant S-transform signal energy for fault at bus 812.

Table 1. Theoretical and S-transform obtained frequencies relevant to fault at bus 812.

Route	Route length (km)	Theoretical frequencies (mode 1) (kHz)	S-transform identified frequency (kHz)
800-812	4×22.57	3.29	3.75
800-808	4×11.4	6.68	8.75
800-810	2×12.92	11.52	11.25

In another test, a 3-phase balanced fault is occurred at bus 814. Figure 3 shows the S-transform energy signal for this case. The characteristic frequencies are expressed in Table 2.

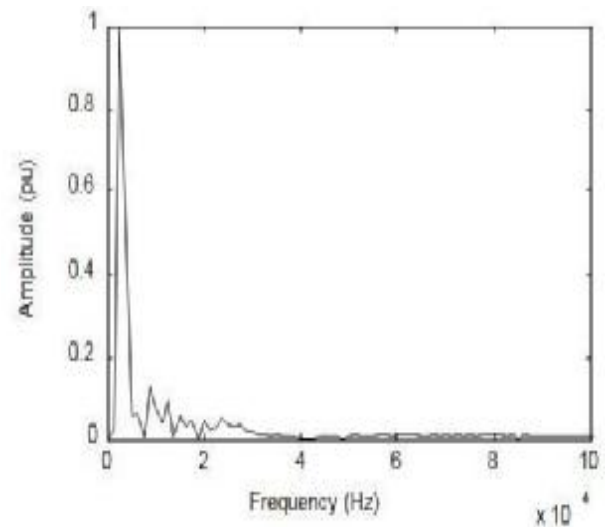

Figure 3. S-transform signal energy for fault at bus 814.

Table 2. Theoretical and S-transform identified frequencies relevant to fault at bus 814.

Route	Route length (km)	Theoretical frequencies (mode 1) (kHz)	S-transform identified frequency (kHz)
800-814	4×31.63	2.35	2.50
800-808	4×11.4	6.68	8.75
800-810	2×12.92	11.52	12.50

Table 3 shows the modal parameters of the Constant Parameters¹ (CP) line model referring to the considered overhead line configuration. The modal parameters are calculated for the frequency of 1 kHz and ground resistivity equal to 100 Ω-m.

Table 3. Modal parameters calculated at 1 kHz and ground resistivity of 100 Ω-m for propagation mode 1.

R (Ω/km)	L(mH/km)	C(μF/km)	Z _c (Ω)	Propagati on velocity (km/s)
0.136	0.908	1.243×10 ⁻²	270.2	2.976×10 ⁵

Some assumptions have been considered as follows:

- All the branches of the network are modeled by CP-overhead lines
- The conductor configuration is the “ID #500” according to appendix-a.
- The network loads are assumed to be located at the end of the lines.
- The power distribution transformers are modeled using the 50 Hz parallel standard model and related distributed capacitors [20] (As shown in appendix).

5.2. Combined overhead lines and underground cables

In order to evaluate the robustness of the proposed method, a network consists of combined overhead lines and underground cables network configuration is investigated in this section. The line between buses 808 and 810 is replaced by a distribution underground cable. A 3-phase balanced fault is applied at bus 810. The S-transform signal energy and characteristic frequencies are shown in Figure 4, Figure 5 and Table 4, respectively. Case 1 points to the network with overhead lines, whereas case 2 denotes to the combined network.

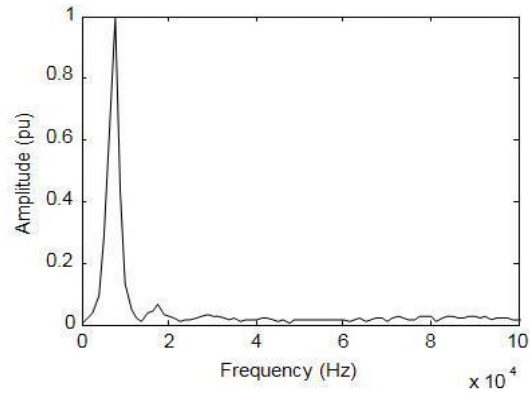

Figure 4. S-transform signal energy for fault at bus 810 in case study No 1.

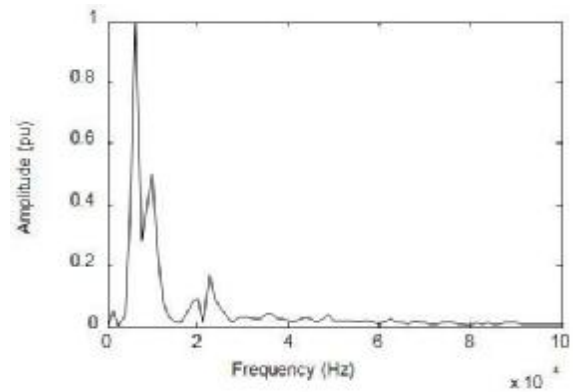

Figure 5. S-transform signal energy for fault at bus 810 in case study No 2.

Table 4. Theoretical and S-transform obtained frequencies relevant to fault at bus 810.

Case No.	Route	Route length (km)	Theoretical frequencies (mode 1) (kHz)	S-transform identified frequency (kHz)
1	800-810	4×12.91	5.76	7.5
2	800-810	4×11.14 4×1.77	5.45	6.25

Based on the simulation results it can be concluded in the case No. 1 (i.e. overhead line network) shows higher characteristic frequencies compared to case No. 2 (i.e. combined overhead line and underground cable network). The theoretical formula also confirms this fact.

6. Conclusion

In this paper, a method based on S-transform for fault location in distribution networks has been proposed. This method uses the characteristic frequencies of transient high frequency voltages originated by faults and S-transform energy signals. The IEEE 34-bus

¹ Constant Parameters

distribution network has been simulated to show the satisfactory performance of the proposed method. The simulation results approve the robustness of this method for fault location in combined overhead line and underground cable distribution networks. In case of future works, it is intended to integrate this method with neural networks in order to make a practical procedure.

7. Appendix

The configuration of combined network is shown in Figure 6.

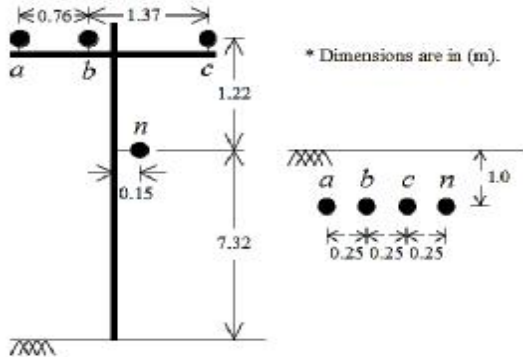

Figure 6. The configuration of combined network (overhead line and underground cable).

Figure 7 shows the transformer model for transient study in this paper.

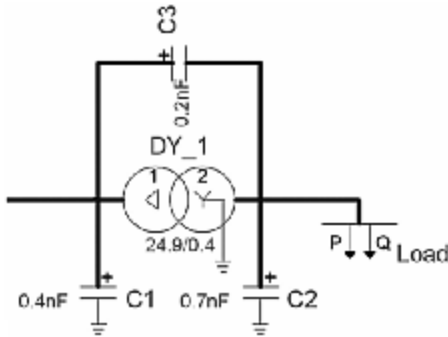

Figure 7. Transformer model for transient study.

IEEE 34-bus distribution test system is shown in Figure 8.

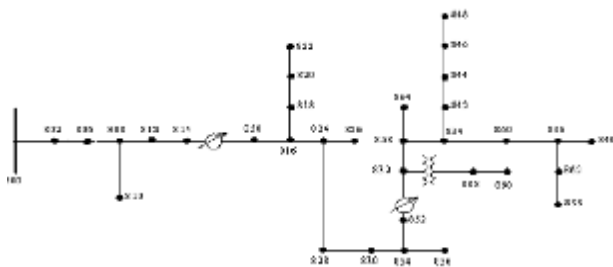

Figure 8. IEEE 34-bus distribution test system.

[1] Billinton R, Allan R.N, Reliability Evaluation of Power Systems, Plenum Press, New York-USA, 1996.

[2] Sachdev M.S, Agarwal R.A, “ Technique for estimating transmission line fault locations from digital impedance relay measurements” IEEE Trans. Power Del, Vol. 3, 1988, 121–129.

[3] Srinivasan K, St-Jacques A, “A new fault location algorithm for radial transmission lines with loads” IEEE Trans. Power Del, Vol. 4, 1989, 1676–1682.

[4] Girgis, A.A, Hart, D.G, Peterson, W.L, “A new fault location technique for two- and three-terminal lines: IEEE Trans. Power Del, Vol. 7, 1992, 98–107.

[5] Liao Y, “Generalized fault-location methods for overhead electric distribution systems” IEEE Trans. Power Del, Vol. 26, 2011, 53–64.

[6] Borghetti A, Bosetti M, Di Silvestro M, Nucci C.A, Paolone M, “Continuous-wavelet transform for fault location in distribution power networks: Definition of mother wavelets inferred from fault originated transients” IEEE Trans. Power Syst, Vol. 23, 2008, 380–388.

[7] Borghetti A, Corsi S, Nucci C.A, Paolone M, Peretto L, Tinarelli R, “On the use of continuous-wavelet transform for fault location in distribution power networks” Elect. Power Energy Syst, Vol. 28, 2006, 608–617.

[8] Borghetti A, Bosetti M, Nucci C.A, Paolone M, “Fault location in active distribution networks by means of the continuous-wavelet analysis of fault originated high frequency transients” CIGRE, Vol. 21, 2010.

[9] Borghetti A, Bosetti M, Nucci C.A, Paolone M, Abur A, “Integrated use of time-frequency wavelet decompositions for fault location in distribution networks: Theory and experimental validation” IEEE Trans. Power Del, Vol. 25, 2010, 3139–3146.

[10] Magnago F.H, Abur A, “Fault location using wavelets” IEEE Trans. Power Del, Vol. 13, 1998, 1475–1480.

[11] Magnago F.H, Abur A, “A new fault location technique for radial distribution systems based on high frequency signals” IEEE Power Eng. Soc. Summer Meeting, 1999, 426–431.

[12] Feizifar B, Haghifam M.R, Soleymani S, “Application of Continuous Wavelet Transform for Fault Location in Combined Overhead Line and Cable Distribution Networks” International Conference on

References

- Electrical and Electronics Engineering ELECO, Bursa, Turkey, 2011, 142-146.
- [13] Chaari O, Meunier M, Brouaye F, "Wavelets: A new tool for the resonant grounded power distribution systems relaying" IEEE Trans. Power Del, Vol. 11, 1996, 1301–1308.
- [14] Stockwell R.G, Mansinha L, Lowe R.P, "Localization of the complex spectrum: The S- transform" IEEE Trans. Signal Processing, Vol. 44, 1996, 998–1001.
- [15] Ahmadimanesh A, Shahrtash S.M, "Employing S-transform for Fault Location in Three Terminal Lines" 10th International Conference on Environment and Electrical Engineering (EEEIC), 2011, 1-4.
- [16] Krishnanand K.R, Balasubramanyam P.V, Swain S.K, Dash, P.K, "S-Transform based Spectral Energy Feature Space for Fault Location Approximation" International Conference on Energy, Automation, and Signal (ICEAS), 2011, 1-5.
- [17] Feizifar B, Haghifam M.R, Soleymani S, Jamilazari A "Impact of Capacitor Banks on Fault Location Methods Based on Fault Transient Signal Analysis in Distribution Networks" 11th International Conference on Environment and Electrical Engineering (EEEIC), 2012, 688-692.
- [18] Clarke E, Circuit Analysis of AC Power Systems, Wiley, New York-USA, 1943.
- [19] Dommel H.W, "Digital computer solution of electromagnetic transients in single and multi-phase networks" IEEE Trans. Power App Syst, Vol. 88, 1996, 388–399.
- [20] Das J.C, Transient in electrical systems, Analysis, Recognition and Mitigation. McGraw-Hill, USA, 2010.