

Adaptive Beamforming for an Underwater MIMO-OFDM Acoustic Communication System Using Basis Expansion Model

Hadis Zare Haghghi, Dariush Abbasi-Moghadam, Seidreza Seydnejad

Abstract—In recent years, Underwater Acoustic Communications (UAC) has been a great matter of consideration because of its importance in different areas such as commercial and military applications. Underwater acoustic communications channel is known as a time-varying and doubly selective channel in both time and frequency domains. The orthogonal frequency division multiplexing (OFDM) modulation is an effective technique to communicate over challenging acoustic channels. In addition, using multiple-input multiple-output (MIMO) systems increases channel capacity which results in high data rate communications. Recently, basis expansion models (BEMs) have been widely used to estimate an underwater acoustic channel. In particular, when the channel is time-varying, the BEM model can effectively estimate the channel with a reduced number of coefficients and low computational complexity. To improve the performance of a MIMO communication channel, various beamforming techniques have been proposed in different areas. Inspired by the basis expansion modeling of an underwater acoustic channel, in this paper we develop a BEM based adaptive space-time beamforming for both the transmitter and receiver of an UAC. The Laguerre basis expansion model is employed in the linearly constrained minimum variance (LCMV) beamformer to obtain an adaptive scheme for updating the beamforming weights at the transmitter and receiver and to optimize the system performance in real-time. Our Simulation results show that the proposed BEM based beamformer method improves the Bit-Error-Rate (BER) and Minimum-Square-Error (MSE) performance substantially for a Rayleigh fading underwater acoustic channel. In particular, our method improves the BER and MSE about 10dB and 4dB compared to the discrete prolate spheroidal sequence (DPSS) method.

Index Terms— Underwater acoustic communications, Basis expansion model (BEM), MIMO-OFDM, Rayleigh fading channel.

Nomenclature

$l_k[n, b]$: Discrete time Laguerre polynomials
 b : Laguerre parameter
 k : Order of discrete time Laguerre polynomial
 $h(n, l)$: Time-varying channel model
 $a_l(n)$: Channel coefficient
 $\tau_l(n)$: Time delay

f_l : Doppler frequency for the l th path
 $x(n)$: The n th transmitted symbol
 $y(n)$: The n th received symbol in the receiver
 $\varphi_m(k)$: Orthogonal basis functions
 $\alpha_{k,m}$: Coefficient corresponding to k th basis function
 $\tau_m(\theta_0)$: Delay of the signal on m th hydrophone
 $\vec{x}(n)$: Signal vector
 \vec{w} : Vector weight
 R_{xx} : Information covariance matrix
 C : Constraint matrix
 P : Image matrix
 \leftrightarrow
 S : Steering matrix
 \vec{v} : Transmitter's weight matrix

I. INTRODUCTION

Underwater Acoustic Communications (UAC) channels are known as bandlimited channels at a low acoustic carrier frequency. This channel is a complex, dynamic communication environment. Due to multiple reflections and scattering from the ocean boundaries, this channel shows several multipaths with a large delay spread. Because of the ocean dynamics, the channel is also time-varying [1]. The orthogonal frequency division multiplexing (OFDM) modulation is an effective technique to communicate over challenging acoustic channels. Multicarrier modulation has been successfully used for an underwater acoustic communication channel. Some examples of coherent demodulation are the block-by-block based OFDM receiver [2-4] and the adaptive OFDM receiver [5, 6]. A challenging factor for the OFDM over the acoustic communication channel is the presence of Doppler spread which destroys the orthogonality among subcarriers and causes the inter-carrier interference (ICI). Elimination of ICI is necessary for improving the receiver performance which in turn needs accurate channel estimation [7, 8].

Estimating a time-varying underwater acoustic channel is a great challenge. Different methods for underwater time-varying channel estimation under the presence of multipath have been summarized in [9]. Channel estimation techniques for OFDM systems can be divided into two categories: blind

and non-blind methods. The blind methods use the statistical behavior of the received signals and require a large amount of data and they suffer performance degradation in fast fading channels. In non-blind methods, some information of the transmitted signal are available to the receiver to be used for the channel estimation [9-10]. In this article, the non-blind channel estimation techniques are employed.

For a doubly-selective fading channel the number of unknown parameters is far greater than the number of pilot symbols. An effective solution to reduce the number of unknowns is using the Basis Expansion Model (BEM) [11, 12]. Instead of estimating each channel coefficient, in BEM one fits a number of basis functions with appropriate coefficients to the channel. Any set of orthogonal functions can be theoretically used to model the channel. However, the best set in practice is the one which matches the channel characteristics most.

The commonly used BEMs for the purpose of underwater acoustic channels are: complex-exponential (CE) BEM which uses the set of orthogonal exponential functions as the basis [13], discrete Fourier transform (DFT) BEM which uses a few low-frequency columns of the inverse DFT matrix as the basis [14], discrete prolate spheroidal sequence (DPSS) which uses the set of eigenvectors corresponding to the largest eigenvalues of the band-limited rectangular power spectrum signal as the basis [15-16].

Fourier basis functions are used in [14] to model the time-varying channel. We can see that the Fourier basis expansion has the following problem: the rectangular window associated with the DFT introduces spectral leakage. The energy from low-frequency Fourier coefficients leaks to the full frequency range and we observe an effect similar to the Gibbs phenomenon.

The Slepian basis expansion represents bandlimited sequences with a minimum number of basis functions avoiding the deficiencies of the Fourier basis expansion. Slepian showed in [17] that time-limited parts of bandlimited sequences span a low-dimensional subspace. The orthogonal basis is spanned by the so-called discrete prolate spheroidal (DPS) sequences. The DPSS BEM provides a closer approximation to the channel and gives better error performance than the DFT BEM, but it has a performance reduction because it colors the noise when converting the channel coefficients into BEM coefficients [17].

The MIMO-OFDM systems have the important advantages of high efficiency, ISI and ICI reduction and reducing the effect of fading and interference [18]. In this paper, we use a MIMO-OFDM system which uses adaptive space-time beamforming over doubly selective underwater acoustic channels. In order to improve the performance of the system the Laguerre filters replace the traditional TDL filters in the Frost beamformer. Importantly, this matches the basis expansion model used to estimate the acoustic channel for an underwater acoustic MIMO-OFDM system.

Laguerre filters are basically IIR filters with only one pole in their structure. This pole is determined through an off-line procedure to optimize the filter response and to guarantee filter stability. Laguerre filters greatly reduce the computational complexity of conventional IIR filters while trying to achieve the minimum point of the given cost function. These features in addition to the great performance

of the Laguerre beamformer make it a very attractive choice for designing broadband beamformers [19].

The paper is organized as follows. The fundamental steps of the Laguerre filter design and the procedure for finding its optimal pole are presented in Section II. In Section III, we introduce the system model with doubly-selective underwater channels and Laguerre BEM. In Section IV we analyze the MIMO-OFDM system with adaptive space-time beamformer. Simulations results are presented in Section V. Finally, concluding remarks are given in Section VI.

We will use bold lowercase and uppercase characters to denote vectors and matrices, respectively. The symbol $(\cdot)^*$ denotes the conjugate operator, $(\cdot)^T$ the transpose operator, and $(\cdot)^H$ the conjugate transpose operator.

I. LAGUERRE FILTERS

In this section principles of the Laguerre filter design are presented.

A. Orthogonal Laguerre functions

Discrete time Laguerre polynomials $l_k[n, b]$ are obtained from the following equation by using Gram-Schmidt orthogonal process [20],

$$l_k[n, b] = \sqrt{1-b^2} \sum_{j=0}^k (-1)^{k+j} \binom{k}{j} \binom{n+k-j}{k} b^{n+k-2j}$$

$$\binom{k}{j} = \frac{k!}{j!(k-j)!}, \quad \binom{n+k-j}{k} = \frac{(n+k-j)!}{k!(n-j)!} \quad (1)$$

where b is the Laguerre parameter ($|b| < 1$), k is the order of the discrete time Laguerre polynomial and n is the discrete time independent variable. It can be shown that the Laguerre basic functions are obtained from the following recursive equation [20],

$$bl_k[n, k] + l_{k+1}[n, b] = l_k[n-1, b] + bl_{k+1}[n-1, b] \quad (2)$$

It can be shown that the discrete-time Laguerre functions have the following transfer functions [19],

$$L_k(z, b) = \sqrt{1-b^2} \frac{(z^{-1}-b)^k}{(1-bz^{-1})^{k+1}}, \quad k = 0, 1, 2, \dots \quad (3)$$

The Laguerre digital filter can be constructed based on (3) as it is shown in Fig. 1. This filter has an infinite impulse response and has one pole which can be determined to ensure a stable response. As it is shown in Fig 1, the Laguerre filter has a simple structure similar to an FIR filter yet it exhibits a performance similar to an IIR filter with guaranteed stability which is an issue in IIR filters. For the same performance, Laguerre filters require much less number of taps compared to FIR filters while providing a linear phase. As it was mentioned earlier, there is only one pole in the structure of the Laguerre filter. This pole is calculated off-line and can be selected to ensure a stable filter. There are three general methods to calculate the pole of the Laguerre filter; Chebyshev error criterion (min-max method), modified

bridging method and the least-squares method which is the most appropriate method [19].

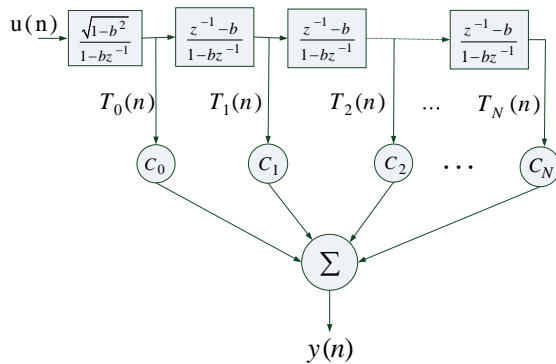

Fig. 1. Digital Laguerre filter of order N [19].

II. SYSTEM MODEL

The underwater acoustic communication channel is a doubly-selective time-varying channel with an impulse response defined as,

$$h(n, l) = \sum_l a_l(n) \delta(n - \tau_l(n)) e^{-j2\pi f_l n} \quad (4)$$

where $a_l(n)$ is the channel coefficient, $\tau_l(n)$ is the delay and f_l is the Doppler frequency for the l th path. By using linear time-variant convolution, the discrete-time received signal in the presence of noise $z(n)$ is given by,

$$y(n) = \sum_{l=0}^L h(n, l) x(n-l) + z(n) \quad (5)$$

where $x(n)$ is the n th transmitted symbol by the transmitter, $y(n)$ is the n th received symbol in the receiver and $z(n)$ is assumed to be i.i.d with $CN(\mathbf{0}, \mathcal{D}^2)$ distribution and $L = \lceil \tau_{\max} / T_s \rceil$ is the number of channel taps.

In order to have high data rate in transmission, OFDM is widely used in underwater acoustic communications to diminish the multipath fading effects. After removing the guard band in the OFDM based system, the output equation can be defined as:

$$\begin{bmatrix} y(0) \\ \vdots \\ y(N-1) \end{bmatrix} = \begin{bmatrix} F_0 \\ \vdots \\ F_{N-1} \end{bmatrix} \begin{bmatrix} H_0(0) & \dots & H_{N-1}(0) \\ \vdots & \ddots & \vdots \\ H_0(N-1) & \dots & H_{N-1}(N-1) \end{bmatrix} \begin{bmatrix} X(0) \\ \vdots \\ X(N-1) \end{bmatrix} + \begin{bmatrix} Z(0) \\ \vdots \\ Z(N-1) \end{bmatrix} \quad (6)$$

where

$$F_k = \begin{bmatrix} e^{-\frac{j2\pi}{N} k_0} & & \\ & \dots & \\ & & e^{-\frac{j2\pi}{N} k_{(N-1)}} \end{bmatrix} \quad (7)$$

$$H_m(k) = \frac{1}{N} \sum_{n=0}^{N-1} h(n, l) e^{\frac{j2\pi m}{N} k_{(n-m)}} \quad (8)$$

$$Z(k) = \sum_{n=0}^{N-1} z(n) e^{-\frac{j2\pi m}{N} k} \quad (9)$$

A. Channel Estimation Using Laguerre Basis Expansion

We assume the channel variation within an OFDM block is not so fast, hence $H_m(k)$ remains constant within a block.

The number of channel coefficients to be estimated is N^2 while the number of known values in the receiver in every OFDM block is equal to N assuming all subcarriers are pilot. To reduce the number of the unknown parameters, the channel can be expressed by basis expansion model as follows [12, 15]:

$$H_m(k) \approx \sum_{m=0}^q \alpha_{k,m} \varphi_m(k) \quad (10)$$

where $\varphi_m(k)$ are orthogonal basis functions and $\alpha_{k,m}$ is the coefficient corresponding to k th basis function. Now for estimating the channel in each OFDM block we have to estimate $q \times N$ coefficients rather than N^2 ($q \ll N$). The simulation results show that an appropriate result can be obtained with $3 < q < 7$. For $q = 3$, equation (6) can be written as:

$$\begin{bmatrix} y(0) \\ \vdots \\ y(N-1) \end{bmatrix}_{(N \times 1)} = \overset{\leftrightarrow}{M}_{(3 \times (3 \times N)) \times} \begin{bmatrix} \alpha_{0,1} \\ \alpha_{0,2} \\ \alpha_{0,3} \\ \vdots \\ \alpha_{N-1,1} \\ \alpha_{N-1,2} \\ \alpha_{N-1,3} \end{bmatrix}_{((3 \times N) \times 1)} + \begin{bmatrix} Z(0) \\ \vdots \\ Z(N-1) \end{bmatrix} \quad (11)$$

where

$$\overset{\leftrightarrow}{M} = \begin{bmatrix} A(0,0) \phi_1(0) & A(0,0) \phi_2(0) & \dots & A(N-1,0) \phi_3(0) \\ \vdots & \vdots & \ddots & \vdots \\ A(0,N-1) \phi_1(N-1) & A(0,N-1) \phi_2(N-1) & \dots & A(N-1,N-1) \phi_3(N-1) \end{bmatrix} \quad (12)$$

where $A(i, j) = X(i) \exp(i, j)$ and $\exp(i, j) = e^{j2\pi \frac{i \times j}{N}}$.

In this case the number of unknowns for channel estimation reduces from $N \times N$ to $3 \times N$. Although the number of unknown parameters are reduced considerably with this method, there is still more than N , the number of given information. To solve this problem we take note of the fact that adjacent channel coefficients are correlated. Thus we need to estimate just a few coefficients and determine the rest with interpolation. Here we assume linear interpolation for simplicity. As an example, assuming 9 pilot symbols and 3 orthogonal basis coefficients, we estimate the 1th, 5th and 9th coefficients as the BEM coefficients and calculate the other coefficients using interpolation. Therefore,

$$H_1(n) = \alpha_{1,1} \varphi_1(n) + \alpha_{1,2} \varphi_2(n) + \alpha_{1,3} \varphi_3(n) \quad (13)$$

$$H_5(n) = \alpha_{5,1} \varphi_1(n) + \alpha_{5,2} \varphi_2(n) + \alpha_{5,3} \varphi_3(n) \quad (14)$$

$$H_9(n) = \alpha_{9,1}\phi_1(n) + \alpha_{9,2}\phi_2(n) + \alpha_{9,3}\phi_3(n) \quad (15)$$

By using linear interpolation between the first and fifth factors, 2th, 3th and 4th factors can be obtained as:

$$\alpha_{k,i} = \left(\frac{\alpha_{5,i} - \alpha_{1,i}}{5-1}\right) \times k - \left(\frac{\alpha_{5,i} - \alpha_{1,i}}{5-1}\right) + \alpha_{1,i} \quad (16)$$

$$i = 1, 2, 3 \quad k = 2, 3, 4$$

where i is the number of the BEM coefficients and k is the number of the coefficients that we calculate. In the same way for 6th, 7th and 8th coefficients, we have:

$$\alpha_{k,i} = \left(\frac{\alpha_{9,i} - \alpha_{5,i}}{9-5}\right) \times k - \left(\frac{\alpha_{9,i} - \alpha_{5,i}}{9-5}\right) + \alpha_{5,i} \quad (17)$$

$$, \quad i = 1, 2, 3 \quad k = 6, 7, 8$$

Then the other channel factors are obtained as follows:

$$H_2(n) = \frac{\alpha_{5,1} + 3\alpha_{1,1}}{4} \phi_1(n) + \frac{\alpha_{5,2} + 3\alpha_{1,2}}{4} \phi_2(n) + \frac{\alpha_{5,3} + 3\alpha_{1,3}}{4} \phi_3(n) \quad (18)$$

$$H_3(n) = \frac{\alpha_{5,1} + \alpha_{1,1}}{2} \phi_1(n) + \frac{\alpha_{5,2} + \alpha_{1,2}}{2} \phi_2(n) + \frac{\alpha_{5,3} + \alpha_{1,3}}{2} \phi_3(n) \quad (19)$$

$$H_4(n) = \frac{3\alpha_{5,1} + \alpha_{1,1}}{4} \phi_1(n) + \frac{3\alpha_{5,2} + \alpha_{1,2}}{4} \phi_2(n) + \frac{3\alpha_{5,3} + \alpha_{1,3}}{4} \phi_3(n) \quad (20)$$

$$H_6(n) = \frac{\alpha_{9,1} + 3\alpha_{5,1}}{4} \phi_1(n) + \frac{\alpha_{9,2} + 3\alpha_{5,2}}{4} \phi_2(n) + \frac{\alpha_{9,3} + 3\alpha_{5,3}}{4} \phi_3(n) \quad (21)$$

$$H_7(n) = \frac{\alpha_{9,1} + \alpha_{5,1}}{2} \phi_1(n) + \frac{\alpha_{9,2} + \alpha_{5,2}}{2} \phi_2(n) + \frac{\alpha_{9,3} + \alpha_{5,3}}{2} \phi_3(n) \quad (22)$$

$$H_8(n) = \frac{3\alpha_{9,1} + \alpha_{5,1}}{4} \phi_1(n) + \frac{3\alpha_{9,2} + \alpha_{5,2}}{4} \phi_2(n) + \frac{3\alpha_{9,3} + \alpha_{5,3}}{4} \phi_3(n) \quad (23)$$

For simplicity, a uniform distribution for pilots is assumed for an OFDM block. For example, for an OFDM block with length of 65, the location of the pilots during the block is given

$$y_p = y(1), y(9), y(17), y(25), y(33), y(41), y(49), y(57), y(65).$$

III. THE PROPOSED METHOD

In this section the design process of our proposed method by using digital Laguerre filter is presented.

Step1. Replace the TDL filters in the conventional structure of the adaptive space-time beamforming with Laguerre filters.

Fig. 2 shows the proposed structure of the system using digital Laguerre filters. The antenna array is assumed a uniform linear array (ULA).

The task of the delay block $T_1(\theta_0), \dots, T_M(\theta_0)$ is to equalize the received signals to different antennas in the

direction of the desired angle [21]. The delay can be defined as:

$$T_m(\theta_0) = \tau_m(\theta_0) + T_0 \quad (25)$$

$$\tau_m(\theta_0) = (m-1) \frac{d}{c} \sin(\theta_0) \quad (26)$$

where in (25) and (26), $\tau_m(\theta_0)$ is the delay of the signal on m th hydrophone compared to reference hydrophone, d is the distance between two adjacent hydrophone, c is the velocity of sound, T_0 the applied delay to avoid negative the $T_m(\theta_0)$

and T is the delay between two adjacent Laguerre filter taps. If we assume $x_{m,j}(n)$ as the sampled signal per tap, according to the frequency conversion functions of the Laguerre filter, it is obvious that [19]:

$$x_{m,1}(n) = bx_{m,1}(n-1) + \sqrt{1-b^2}r_m(n)$$

$$x_{m,j}(n) = x_{m,j-1}(n-1) + bx_{m,j}(n-1) - bx_{m,j-1}(n-1) \quad (27)$$

$$m = 1, 2, \dots, M \quad j = 2, 3, \dots, J$$

where $x_m(n)$ is the broadband signal in the m th hydrophone after the m th delay block.

Step2. Calculating the optimum pole of the Laguerre filter based on the bandwidth of the signal by using the MSE method.

Step3. Determine the Laguerre filter weights by minimizing the beamformer output power, Meanwhile, we have to keep to the direction of the desired signal.

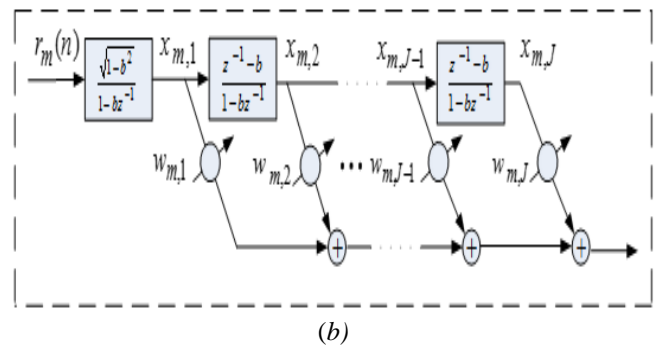
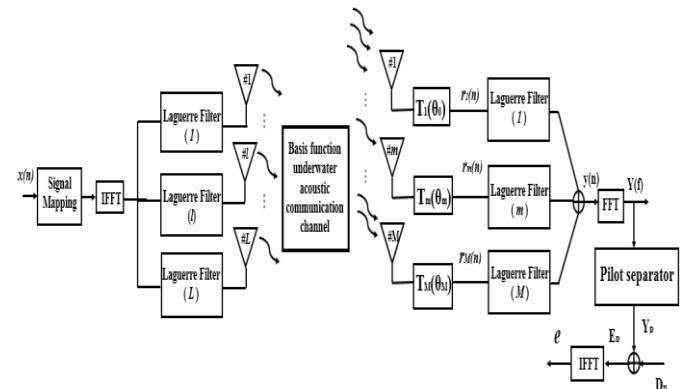

Fig. 2. (a) The overall structure of the proposed MIMO-OFDM based system using Laguerre beamformer and expansion of orthogonal Laguerre functions, (b) m th branch of the Laguerre filter in the beamformer in transmitter and receiver

In many environments, the statistical information of the signal are constantly changing; as a result, the beamformer weights should also change to have the best response in the beamformer output. If the information of the desired signal is not available, and only the frequency band of the desired signal and its arrival angle to the antenna array are available, we can use adaptive Linearly Constrained Minimum Variance (LCMV) algorithm to calculate the array weights [22].

It should be noted that steps 1 and 2 are performed only once and only step 3 have to be performed adaptively.

A. Updating the Receiver Weights

We define $\vec{x}(n)$ as the signal vector and \vec{w} as the vector weight with size $(MJ \times 1)$ as following:

$$\vec{x}(n) = [x_{11}(n) \dots x_{M1}(n) \dots x_{1J}(n) \dots x_{MJ}(n)]^T \quad (28)$$

$$\vec{w} = [w_{11} \dots w_{M1} \dots w_{1J} \dots w_{MJ}]^T \quad (29)$$

The output of the beamformer in Fig.3 can be written as [22]:

$$y(n) = \vec{w}^T \vec{x}(n) \quad (30)$$

To remove the interfering signals, output power must be minimized while we have to keep on the direction of the desired signal, so the optimization problem is obtained as [23]:

$$\begin{cases} \min_w & w^T \vec{R}_{xx} w \\ s.t & C^T w = f \end{cases} \quad (31)$$

where R_{xx} is the information covariance matrix, C is the constraint matrix and f is the constraint vector. It has shown that by using LMS algorithm and estimation R_{xx} by

$$\frac{XX^T}{r!(n-r)!},$$

the updating equation of the receiver weights can be obtained as [23]:

$$\begin{cases} w(n+1) = P[w(n) - \mu y(n)x(n)] + F \\ w(0) = F \end{cases} \quad (32)$$

where μ is the step size of the correction algorithm, C is the constraint matrix, $f = [1 \ 0 \ \dots \ 0]^T$ is the constraint vector, $\mathbf{1}_M = [1 \ 1 \ \dots \ 1]^T$ and $\mathbf{0}_M = [0 \ 0 \ \dots \ 0]^T$ are the vectors containing M one and M zero, respectively. P is the image matrix on the null space of C and g is the beginning answer vector which is calculated by the following equations:

$$P = I_{MJ} - C(C^T C)^{-1} C^T \quad (33)$$

$$g = C(C^T C)^{-1} f \quad (34)$$

$$C = \begin{bmatrix} \mathbf{1}_M & \mathbf{0}_M & \dots & \mathbf{0}_M \\ \mathbf{0}_M & \mathbf{1}_M & \dots & \mathbf{0}_M \\ \vdots & \vdots & \ddots & \vdots \\ \mathbf{0}_M & \mathbf{0}_M & \dots & \mathbf{1}_M \end{bmatrix} \quad (35)$$

B. Updating the Transmitter Weights

Similar to the receiver weights, the transmitter weights also need to be updated in each OFDM block. The transmitter weights are calculated in the receiver by using pilot symbols and BEM coefficients in order to minimize the power of the error signal. Because all the information is available in the receiver, this update is performed in the receiver and the updated weights are sent to the transmitter through a feedback channel. We need channel information and receiver weights to calculate transmitter weights. Assume $\vec{r}(n)$ is the received signal on the receiver hydrophones. $\vec{r}(n)$ can be obtained by convolution of the channel and the data transmitted signal as:

$$\vec{r}(n) = \vec{h} \vec{s} \vec{x} \vec{v} + \vec{z}(n) \quad (36)$$

where the parameters in the equation (39) are defined as the following.

\vec{s} is the steering matrix:

$$\vec{s} = \begin{bmatrix} \vec{s}_1 \\ \vec{s}_2 \\ \vdots \\ \vec{s}_k \end{bmatrix} \quad (37)$$

where in equation (37)

$$\vec{s}_k = \vec{I}_J \otimes \vec{s}_k \quad (38)$$

$$\vec{s}_k = \text{diag}(\vec{s}'_1, \vec{s}'_2, \dots, \vec{s}'_{N_t}) \quad (39)$$

$$\vec{s}'_{m_t} = \vec{I}_{J_t} \otimes \vec{s}^k_{m_t} \quad (40)$$

$$\vec{s}^k_{m_t} = \text{diag}(\vec{s}^k_{m_t}) \quad (41)$$

$$\vec{s}^k_{m_t} = \begin{bmatrix} s^k_{m_t,1} & s^k_{m_t,2} & \dots & s^k_{m_t,L} \end{bmatrix}_{L \times 1}^T \quad (42)$$

where $\vec{s}^k_{m_t}$ is a diagonal matrix and its elements on main

diagonal are $s^k_{m_t}$, where $s^k_{m_t}$ is the steering vector including all path delays between the m th hydrophone and the k th hydrophone compared to the first hydrophone as the reference.

If we assume $s^k_{m_t,l}$ as the l th path delay, it can be defined as:

$$\begin{aligned} s^k_{m_t,l} &= e^{\frac{j2\pi}{\lambda}(k-1)d \cos(\theta^k_{m_t,l})} e^{-\frac{j2\pi}{\lambda}(m_t-1)d \cos(\theta^k_{m_t,l})} \\ &= e^{\frac{j2\pi}{\lambda}(k-m_t)d \cos(\theta^k_{m_t,l})} \end{aligned} \quad (43)$$

where λ is the wavelength corresponding to the main carrier frequency and $\theta^k_{m_t,l}$ is the angle of the l th path between m th transmitter transducer and k th hydrophone.

Matrix $\vec{x}(n)$ includes all transmitted signals as:

$$\vec{x}(n) = \begin{bmatrix} \vec{x}(n) & \vec{0}_{L \times 1} & \dots & \vec{0}_{L \times 1} \\ \vec{0}_{L \times 1} & \vec{x}(n) & \dots & \vec{0}_{L \times 1} \\ \vdots & \vdots & \ddots & \vdots \\ \vec{0}_{L \times 1} & \vec{0}_{L \times 1} & \dots & \vec{x}(n) \end{bmatrix}_{M_t L \times M_t} \quad (44)$$

where $\vec{x}(n)$ consists of all symbols of transmitted signal from different paths as:

$$\vec{x}(n) = [x(n) \ x(n-1) \ \dots \ x(n-L+1)]_{L \times 1}^T \quad (45)$$

Vector \vec{v} includes transmitter's weights as:

$$\vec{v} = [v_1 \ v_2 \ \dots \ v_{M_t}]_{M_t \times 1}^T \quad (46)$$

Vector $\vec{z}(n)$ is including noise and undesirable interference as:

$$\vec{z}(n) = [z_1(n) \ z_2(n) \ \dots \ z_{M_r}(n)]^T \quad (47)$$

Therefore, the matrix of the gain of channel paths gain is defined as:

$$\vec{h} = \begin{bmatrix} \vec{\alpha}_1^1 & \vec{\alpha}_2^1 & \dots & \vec{\alpha}_{M_t}^1 & 0_{1 \times (M_r-1)M_t L} \\ 0_{1 \times M_t L} & \vec{\alpha}_1^2 & \dots & \vec{\alpha}_{M_t}^2 & 0_{1 \times (M_r-2)M_t L} \\ \vdots & \vdots & \vdots & \vdots & \vdots \\ 0_{1 \times (M_r-1)M_t L} & \vec{\alpha}_1^{M_r} & \vec{\alpha}_2^{M_r} & \dots & \vec{\alpha}_{M_t}^{M_r} \end{bmatrix} \quad (48)$$

where $\vec{\alpha}_{m_t}^{m_r}$ includes channel BEM coefficients for all paths between m_t th transmitter transducer and m_r th hydrophone defined as :

$$\vec{\alpha}_{m_t}^{m_r} = [\alpha_{m_t,1}^{m_r} \ \alpha_{m_t,2}^{m_r} \ \dots \ \alpha_{m_t,L}^{m_r}]_{1 \times L} \quad (49)$$

Now we can express the output of the beamformer by using equation (36) as:

$$y(n) = \vec{w}^H (\vec{h} \vec{s} \vec{x} \vec{v} + \vec{z}(n)) \quad (50)$$

The transmitter weights should be determined such that the power of the error signal is minimized while the transmitter power stays fixed. It means that $\vec{v}^H \vec{v} = 1$. Hence, the optimization problem for the transmitter can be defined as:

$$\begin{cases} \min E \{ |e(n)|^2 \} \\ \vec{v}^H \vec{v} = 1 \end{cases} \quad (51)$$

where $e(n)$ is the error signal of the beamformer output and pilot symbol corresponding to desired signal. It is shown that by solving equation (54) in addition to using the method of Lagrange multiplier and LMS algorithm, transmit beamforming weights can be obtained as [23]:

$$\vec{v}(q+1) = \vec{v}(q) + \mu_v \sum_{n=1}^N (\vec{I} - \frac{\vec{v}(q)\vec{v}^H(q)}{M_t}) \vec{x}^H \vec{s}^H \vec{h}^H \vec{w}(q) e(n, q) \quad (52)$$

where $\vec{v}(q+1)$ is the transmitter's weights vector for $(q+1)$ th OFDM block. μ_v is the step size parameter for LMS algorithm, $e(n, q)$ is the error signal of q th block and \vec{I} is the unitary matrix with size $M_t \times M_t$.

IV. SIMULATION RESULTS

In this section, we evaluate the performance of the proposed method by means of MATLAB simulation and compare it with other BEMs commonly used in underwater communications.

Because of the time-varying nature of the underwater channel, the channel is simulated randomly similar to the conditions of article [25]. The simulated channel owns 10 paths with coefficients $a_l(n)$ whose distributions are Rayleigh and follows equation (8). Meanwhile the average power decreases exponentially with the delay and the delay $\tau_l(n)$ has an exponential distribution with a mean of 1 ms. Also, the Doppler rate of each path is assumed a zero mean Gaussian distribution. The speed of sound in water c is set to 1500 m/s. In addition, the carrier frequency is set to 15KHz, i.e. $f_c = 15\text{kHz}$, with 10kHz bandwidth. The channel response and its estimation by using Laguerre basis expansion are illustrated in Fig.3. It can be observed that the estimation is very close to the real channel.

For the communication, we assume a MIMO-OFDM system where each OFDM block has 64 subcarriers with 16-QAM modulation and pilot subcarriers are uniformly distributed in the block. The constellation maps of a MIMO-OFDM system, for different number of transmitter transducer with SNR=20 dB are presented in Fig 4. As it can be seen, the symbols can be well separated with our beamforming scheme.

In order to eliminate the ISI, the guard-band T_g has to be more than the maximum channel delay. We choose $T_g = 20\text{ms}$.

One desired signal at 90° and two interferences at 40° and 160° are assumed, and all sources are assumed to be independent of each other. The angle spreads of different paths are set to $\pm 10^\circ$. The number of the transmitter transducers and hydrophones are respectively 4 and 6, respectively. Also, we consider the Laguerre filter with 5 taps in both sides. Fig.5 plots the MSE graphs as a function of the number of OFDM blocks for different BEM methods including CEB EM, DFT BEM, DPS BEM and Laguerre BEM at SNR=20dB. It can be observed that the performance of the proposed system is better than the other BEMs and the MSE is decreased about 4dB.

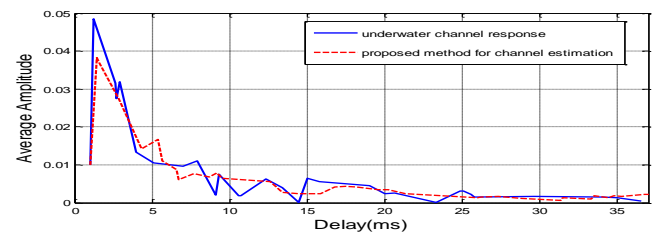

Fig.3. Underwater acoustic channel response and its estimation by using Laguerre basis expansion.

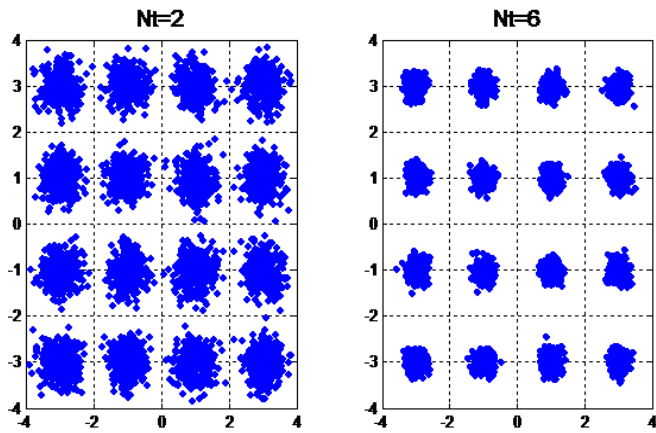

Fig.4. Constellation maps of a MIMO-OFDM system, for different number of transmitter transducer with SNR=20 dB.

Fig. 6 shows the BER as a function of the SNR for CE BEM, DFT BEM, DPS BEM and Laguerre BEM. It can be seen that the proposed method improves the BER. It can be observed from Figs.5 and 6 that the performance of the proposed estimation method is better than the other BEMs. This improvement is due to the better performance of the orthogonal Laguerre functions to follow the variation of the channel as well as the matching created by the transmitter, channel and receiver in the proposed system. The receiver weights are set in order to compensate the channel effect and to enhance the performance of the system.

more focused beam at the transmitter array which results in suppressing the interferences more than before. In order to investigate the proposed system performance, Fig.9 shows the effect of increasing the pilot symbols. As we expect, increasing the number of pilot symbols causes the LMS algorithms to converge faster and consequently the BER improves greatly.

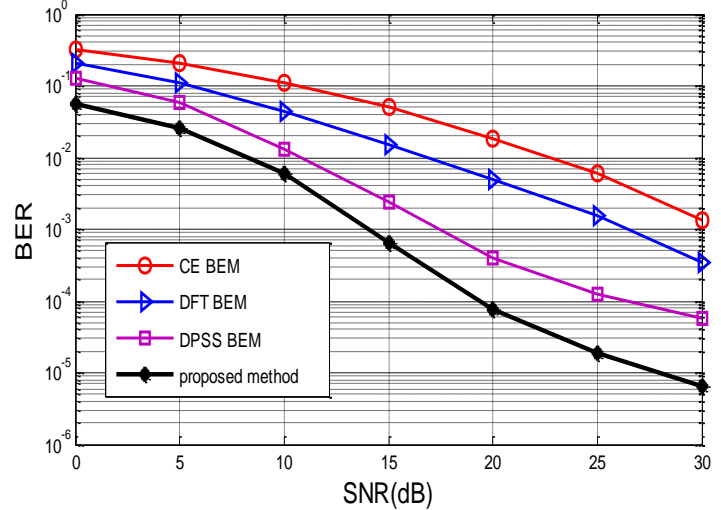

Fig. 6. The BER as a function of the SNR for CEB EM, DFT BEM, DPS BEM and Laguerre BEM

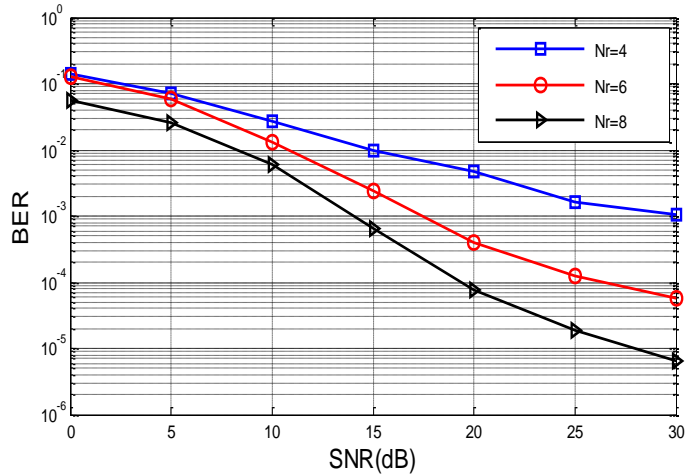

Fig. 7. The BER as a function of the SNR for Nr=4, 6 and 8.

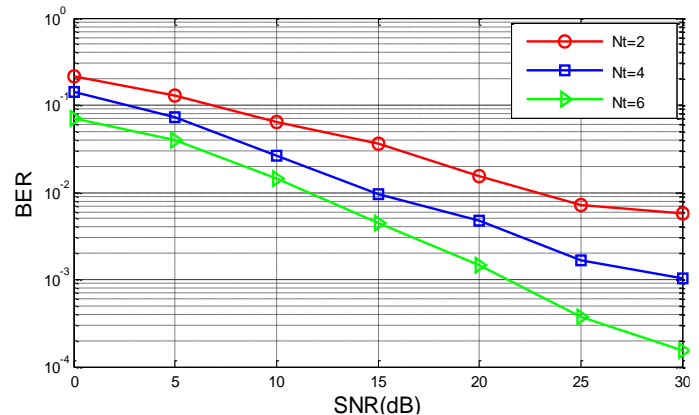

Fig. 8. The BER as a function of the SNR for N_t=2, 4 and 6.

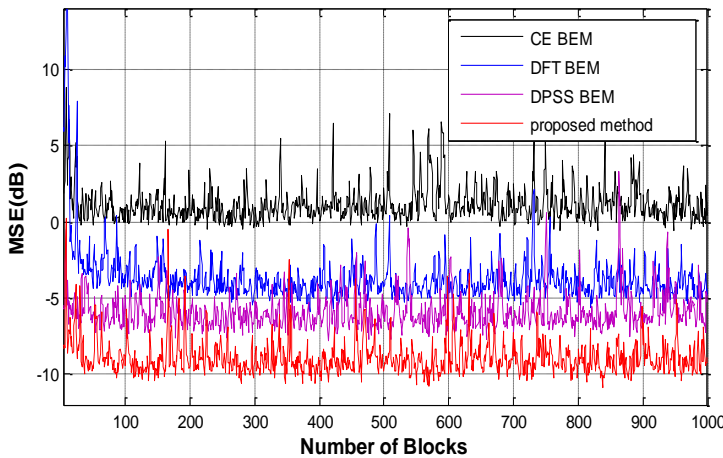

Fig.5. MSE as a function of number of blocks for CEB EM, DFT BEM, DPS BEM and Laguerre BEM at SNR of 20dB.

The effect of increasing the number of the hydrophones on the BER in the proposed system is shown in in Fig. 7 with transmitter transducer 4.

In Fig. 8 we assume 6 hydrophone and 8 pilot subcarriers in all OFDM blocks, then the number of hydrophones is increased from one to six. It is obvious that by increasing the number of receiving antennas the BER improves significantly because by boosting the number of the hydrophones, the resolution of the system increases and the desired signal is separated easier from other interfering signals. Fig.8 shows that by increasing the number of transmitter transducer, BER decreases. This is due to the fact that, in this case we have a

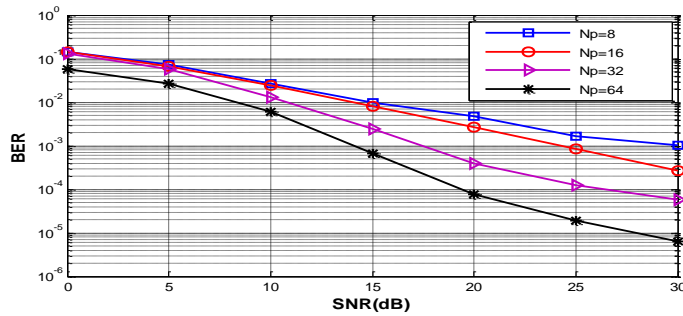

Fig. 9. The BER as a function of the SNR for $N_p=8, 16, 32, 64$.

The selection of the number of the pilots depends on the channel condition. If the channel variation is smooth and relatively small, the number of pilots which is needed is low. On the other hand, if the channel is fast time-varying, to improve the system performance, the number of pilots must be increased.

In order to compare performance of proposed method with and without beamforming, the BER curve is plotted in Fig. 10. We assume a single-input single-output (SISO) system, a single-input multi-output (SIMO) system which uses adaptive space-time beamforming in the receiver and a MIMO system which uses adaptive space-time beamforming in both transmitter and receiver. As we can see, using beamforming improves the system performance and significantly decreases BER.

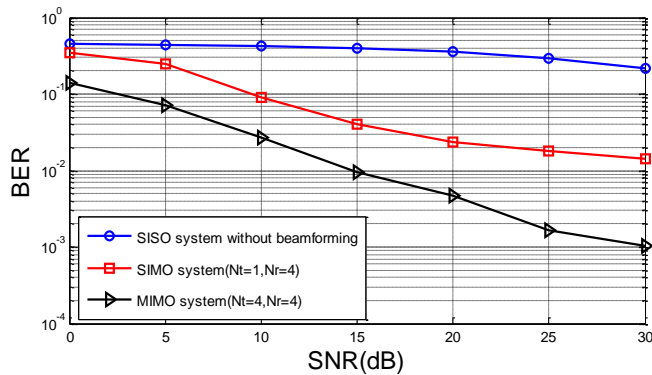

Fig. 10. The BER as a function of the SNR for the proposed method with and without beamforming

In order to show the great performance of the system in an UAC channel, Fig.11 show the BER as a function of the number of paths for different number of hydrophones and SNR=20dB. As we can see by increasing the number of paths, the BER increase. In this case increasing the number of hydrophones can improve the system performance.

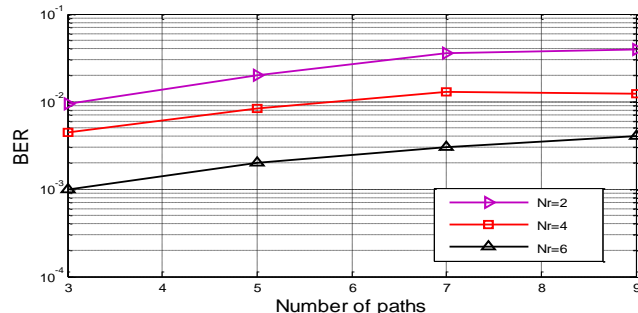

Fig. 11. The BER as a function of the number of paths for different number of hydrophones with SNR=20dB

In order to compare the proposed method with traditional TDL filters, Fig.12 shows The BER as a function of the SNR for the proposed method and a Frost beamformer which uses TDL filters. For simulation we assume four transmitter transducer, six hydrophones and SNR=20dB. The simulation results show the good performance of the proposed method in compare to Frost beamformer. We can see that the robustness of proposed method in an UAC channel is better than a TDL beamformer.

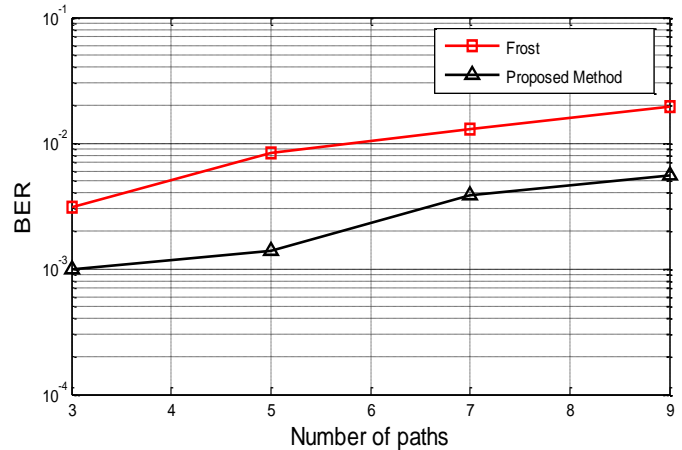

Fig. 12. The BER as a function of the number of paths for the proposed method and a Frost beamformer

Fig.13 plots the BER as a function of SNR for the proposed method and a Frost beamformer. For the simulation we assume four transmitter transducer and four hydrophones. It is obvious that the proposed method has a good performance. As we can see in SNR=20dB the proposed method is 10dB better than of the Frost beamformer.

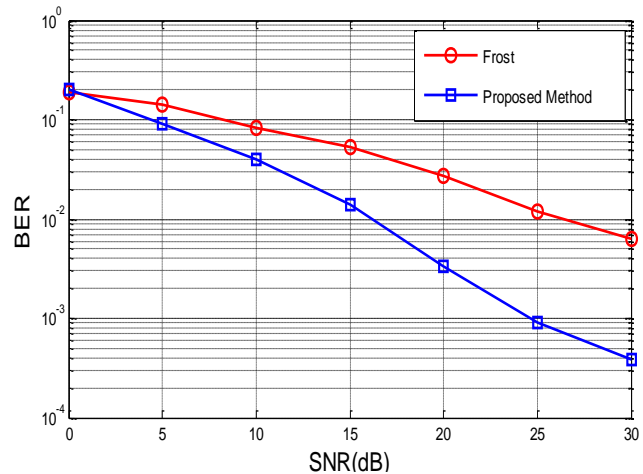

Fig. 13. The BER as a function of SNR for the proposed method and a Frost beamformer

One of the important advantages of the proposed method is the reduction of the computational load compared to Frost beamformer. Table 1 shows the volume of computation of proposed method and Frost beamformer to have the same performance for both systems.

TABLE I
THE VOLUME OF COMPUTATION OF THE PROPOSED METHOD
AND FROST BEAMFORMER

Beamformer	Proposed method	Frost
Number of weights	6	16
Number of multiply in each repetition	49	289
Number of summation in each repetition	47	287

In order to investigate the ability of the proposed system for environmental interference removal, the received beampattern is plotted in Fig.14 whereas Fig.15 shows the transmitted beampattern for the proposed system.

As we know, when the transmitter or receiver beamformer weights reach their optimal values, the main lobe of the patterns should point to the receiver angle. We assume a MIMO-OFDM system with four transmitter transducers and six hydrophones with 8 pilots. It can be observed that the efficacy of the beamforming in the receiver is better than the transmitter. By increasing the number of the transmitter transducers and hydrophones we can have directional patterns which provide better selectivity for the receiver at the desired direction and it also imposes higher attenuation to the interference sources. In addition, beampatterns can also exhibit clear nulls at interference directions.

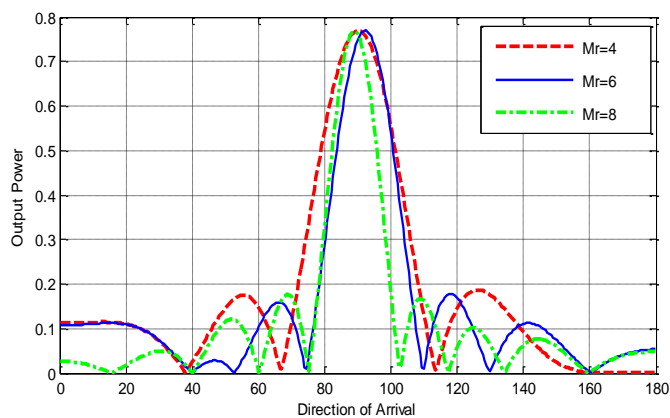

Fig.14. Receiver beampattern for $M_r=4, 6, 8$ in proposed system

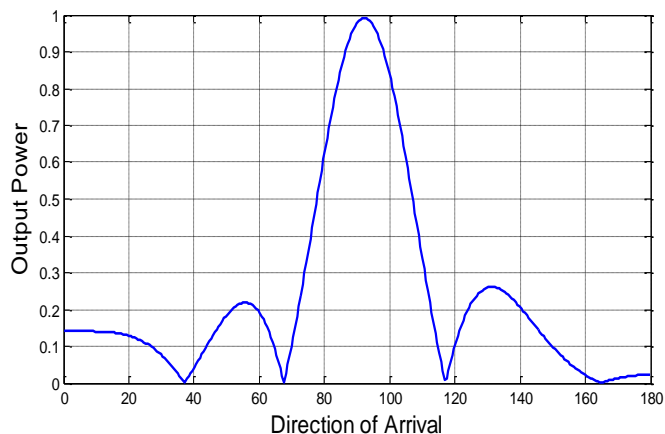

Fig.15. Transmitter beampattern $M_t=4$ in proposed system

V. CONCLUSION

The time-varying nature of the underwater acoustic communication channels is a big challenge for communicating over this channel. In this paper, a new BEM based on orthogonal Laguerre functions was proposed both for channel estimation and beamforming for a MIMO-OFDM system. It was shown that the Laguerre basis expansion model has the ability to follow the channel variation in real-time. Then the BEM coefficients were estimated with an appropriate accuracy using Newton interpolation. A new MIMO-OFDM system, in which adaptive beamforming was utilized in both transmitter and receiver was also proposed. It is notable that in this system the adaptive beamformer was constructed based on Laguerre filter design. In order to have matching between transmitter, receiver and the channel, Laguerre basis expansion was used to estimate the channel coefficients as well as adaptive beamforming. The better performance of the proposed method compared to the other common BEMs was also illustrated. As we can see, the simulation results show a great improvement in performance. The BER and MSE improve about 10dB and 4dB in comparison with DPSS BEM. The advantages of the proposed method can be enumerated as: reduction of the number of weights, reduction of the volume of computation, real-time design and great performance improvement. Due to the inherent stability of the Laguerre filters compared to IIR filters, we are not concerned about any instability issue in real-time scenarios.

REFERENCES

- [1] M. Chitre, S. Shahabudeen, and M. Stojanovic, "Underwater acoustic communications and networking: Recent advances and future challenges," *Marine Technology Society Journal*, vol. 42, no. 1, pp. 103–116, 2008.
- [2] B. Li, S. Zhou, M. Stojanovic, L. Freitag, and P. Willett, "Multicarrier communication over underwater acoustic channels with nonuniform Doppler shifts," *IEEE J. Ocean. Eng.*, vol. 33, no. 2, pp. 198–209, Apr. 2008.
- [3] T. Kang and R. A. Iltis, "Iterative carrier frequency offset and channel estimation for underwater acoustic OFDM systems," *IEEE J. Select. Areas Commun.*, vol. 26, no. 9, pp. 1650–1661, Dec. 2008.
- [4] J. J. Tao and Y. R. Zheng, "Turbo detection for MIMO-OFDM underwater acoustic communications," *International Journal of Wireless Information Networks*, vol. 20, no. 1, pp. 27–38, Mar. 2013.
- [5] M. Stojanovic, "Low complexity OFDM detector for underwater channels," in *Proc. of MTS/IEEE OCEANS Conference*, Boston, MA, Sept. 18–21, 2006.
- [6] M. Stojanovic, "OFDM for underwater acoustic communications: Adaptive synchronization and sparse channel estimation," in *Proc. of Intl. Conf. on ASSP*, Las Vegas, NV, Apr. 2008.
- [7] K. Tu, D. Fertonani, T. M. Duman, M. Stojanovic, J. G. Proakis, and P. Hursky, "Mitigation of intercarrier interference for OFDM over time-varying underwater acoustic channels," *IEEE Journal of Oceanic Engineering*, vol. 36, no. 2, pp. 156–171, Apr. 2011.
- [8] J.-Z. Huang, S. Zhou, J. Huang, C. R. Berger, and P. Willett, "Progressive inter-carrier interference equalization for OFDM transmission over time-varying underwater acoustic channels," *IEEE J. Select. Topics Signal Proc.*, vol. 5, no. 8, pp. 1524–1536, Dec. 2011.
- [9] A. Radosevic, R. Ahmed, T. M. Duman, J. G. Proakis, and M. Stojanovic, "Adaptive OFDM modulation for underwater acoustic communications: Design considerations and experimental results," *IEEE Journal of Oceanic Engineering*, 2014, to appear.
- [10] M. Ozdemir, H. Arslan, Channel estimation for wireless OFDM systems, *IEEE Commun. Surv. Tutorials* 9 (2) (2007) 18–48.

- [11] X. Ma, G. B. Giannakis, and S. Ohno, "Optimal training for block transmissions over doubly selective wireless fading channels," *IEEE Trans. on Signal Processing*, vol. 51, no. 5, pp. 1351–1366, May 2003.
- [12] [12] F. Qu and L. Yang, "Basis expansion model for underwater acoustic channels?," presented at the MTS/IEEE OCEANS Conf., Quebec City, Quebec, Canada, Sep. 2008
- [13] G. Taubock, F. Hlawatsch, D. Eiwen, H. Rauhut, Compressive estimation of doubly selective channels in multicarrier systems: leakage effects and sparsity enhancing processing, *IEEE J. Sel. Top. Signal Proces.* 4 (2) (2010) 255–271.
- [14] F. Pena-Campos, R. Carrasco-Alvarez, O. Longoria-Gandara, R. Parra-Michel, Estimation of fast time-varying channels in OFDM systems using two-dimensional prolate, *IEEE Trans. Wireless Commun.* 12 (2) (2013) 898–907.
- [15] H Yu, A Song, M Badiy, F Chen, F Ji "Iterative estimation of doubly selective underwater acoustic channel using basis expansion models" *Ad Hoc Networks*, Elsevier, pp.1-10, 2015.
- [16] H. L. V. Trees, *Detection, Estimation, and Modulation Theory*. Wiley-Interscience, New York, September 2001.
- [17] T. Zeman and C. F. Mecklebr"auker, "Time-variant channel estimation using discrete prolate spheroidal sequences," *IEEE Trans. on Signal Processing*, vol. 53, no. 9, pp. 3597–3607, September 2005.
- [18] X. Wang, Ho. P. , "Robust channel estimation and ISI cancellation for OFDM systems with suppressed features", *IEEE J Selected Areas in Communications*, Vol. 23, pp. 963-072, 2005.
- [19] S. R. Seydnejad and R. Ebrahimi, "Broadband beamforming using Laguerre filters," *Elsevier J. Signal Process.*, vol. 92, pp. 1093–1100, 2012.
- [20] M.A. Masnadi-Shirazi, M. Aleshams," *Laguerre discrete-time filter design*", Pergamon J. Comput. Electric. Eng. Vol. 29, pp. 173-192, 2003.
- [21] C. K. Kim, K. Lee and Y.S. Cho, "Adaptive Beamforming Algorithm for OFDM Systems with Antenna Arrays" *IEEE Trans. on Consumer Electronic*, VOL.64,NO.4,pp.1052-1058,2000.
- [22] W. Liu, "Adaptive wideband beamforming with sensor delaylines", *Signal Processing* 89 (2009) 876–882
- [23] L. C. Godara, *Smart Antennas*. CRC Press, 2004.
- [24] E Asadollahi-Yazdi, SR Seydnejad, "Post-FFT Beamforming in a Pilot-Assisted MIMO-OFDM System", *Wireless Pers Commun*, Springer, Vol. 79, pp.2195–2208, 2014
- [25] Z.-H. Wang, S. Zhou, G. B. Giannakis, C. R. Berger, and J. Huang, "Frequency-domain oversampling for zero-padded OFDM in underwater acoustic communications," in *Proc. IEEE Global Commun. Conf.*, Miami, FL, Dec. 2010, DOI: 10.1109/GLOCOM.2010.