

A Hybrid Adaptive Neuro-Fuzzy Inference System-Particle Swarm Optimization Model for Predicting Corrosion Rate of 3C Steel Considering Different Marine Environment Factors

Abasali Ansarinezhad and Mehdi Shahbazian*

Abstract—This research aims to describe a novel model, namely Hybrid Adaptive-Neuro Fuzzy Inference System-Particle Swarm Optimization (ANFIS-PSO), for predicting corrosion rate of 3C steel considering different marine environment factors. In the present research, five parameters (temperature, dissolved oxygen, salinity, pH, and oxidation–reduction potential) were used as input variables, with corrosion rate being the only output variable. In the proposed hybrid ANFIS-PSO model, the PSO served as a tool to automatically search for and update optimal parameters for the ANFIS, so as to improve generalizability of the model. Effectiveness of the hybrid model was then compared those to two other models, namely Adaptive-Neuro Fuzzy Inference System–Genetic Algorithm (ANFIS-GA) and Support Vector Regression (SVR) models, by evaluating their results against the same experimental data. The results showed that the proposed hybrid model tends to produce a lower prediction error than those of ANFIS-GA and SVR with the same training and testing datasets. Indeed, the hybrid ANFIS-PSO model provides engineers with an applicable and reliable tool to conduct real-time corrosion prediction of 3C steel considering different marine environment factors.

Keywords: corrosion prediction, Adaptive Neuro-Fuzzy Inference System (ANFIS), Particle Swarm Optimization (PSO), Support Vector Regression (SVR), steel

I. INTRODUCTION

One of the most important metallic materials used across various industries is 3C steel. It has various chemical compositions. Since 3C steel is made from different materials of a wide spectrum of chemical compositions, it is subjected to several types of defect when exposed to seawater environment. Corrosion, indeed, is the leading cause of the defects; it involves degradation of materials (e.g. steel, reinforced concrete and hybrid structures) via chemical or electrochemical alterations, and can proceed via a wide variety of mechanisms. Corrosion mechanism is complicated, but it is generally agreed that most of corrosion mechanisms involve an electrochemical

reaction. Limitations on corrosion-related measurements (e.g. experimental cost and large number of environmental variables which makes it practically impossible to model all of them at the same time) have led to a situation where only limited number of experimental datasets on corrosion are available. These facts has set the scene for the available corrosion data to be typically acquired from small number of samples with large dimensions, with their factors being strongly correlated to one another. Interacting factors affecting corrosion make it a challenge to undertake an accurate analysis of the corrosion. Prediction of corrosion rate is essential for decision-making on the design, maintenance, and management of industrial processes and operations.

As such, a large deal of research has been focused on the subject matter of corrosion, with some of the research being conducted on real corrosion data and corresponding environmental parameters [1-5]. Due to the non-linear relationship between corrosion rate and contributing parameters (that interact with one another as well), it is difficult to set up a descriptive model of corrosion rate using ordinary mathematic modeling [6, 7]. To study the corrosion behavior and corrosion-induced damages, researchers have proposed many models and kinetic equations employing multiple linear regression techniques [8, 9].

Several models have been proposed to predict corrosion in carbon steel, such as the empirical formulae proposed in Refs. [10, 11]. Feliu *et al.* [8] proposed a general equation to describe corrosion phenomenon: $C = At^n$, where A is the corrosion in the first year, t is the time for which the model is exposed to corrosive environment (in years), C is the corrosion after t years, and n is a material-dependent constant which was proposed to be 0.44 for steel. Aiming at evaluating the damage of carbon steel as a function of some environmental variables, Diaz and Lopez [12] used an artificial neural network (ANN) model. Following another neural network model-based approach, El-Abbasy *et al.* applied ANN models to simulate (and thereby predict) the conditions to which offshore oil and gas pipelines are exposed [2]. Furthermore, Fuzzy Logic (FL) approach was proposed to estimate corrosion failures along oil

Manuscript received December 15, 2016; accepted May 22, 2017

Abasali Ansarinezhad, Mehdi Shahbazian Department of Instrumentation and Automation, Petroleum University of Technology, Ahwaz, Iran

Corresponding Author. E-mail addresses: abasansarinezhad@put.ac.ir (A. Ansarinezhad), shahbazian@put.ac.ir (M. Shahbazian).

and gas pipelines [13, 14]. Ling and Dong-Mei [15] proposed support vector regression (SVR) for predicting corrosion rate. Wen *et al.* [10] applied a PSO-based SVR model for optimizing SVR parameters and integrating leave-one-out cross-validation into it (SVR-LOOCV) to predict corrosion rate of 3C steel. They presented a comparison between experimentally measured and predicted corrosion rates by SVR-LOOCV and Back-Propagation Neural Network (BPNN) modeling on the same dataset. Accordingly, they suggested that BPNN is not an appropriate and reliable method for predicting the rate of corrosion due to lack of a unified mathematical theory, its adverse effect on global optimization, and its tendency toward over-fitting. In addition, they found that the limited extrapolation capability is an important disadvantage of the SVR model.

Therefore, this paper aims to find an alternative method for updating the center and spread of the membership functions in ANFIS. Establishing an ANFIS model is a required step when choosing a proper set of Gaussian-function parameters is aimed. To prevent the problems mentioned in previous works, a smart integrated method is used to estimate corrosion rate of 3C steel at a higher accuracy. The choice of the smart integrated method is a key step in finding optimal ANFIS parameters.

In this paper, applying a modern regression algorithm, namely ANFIS, a small set of factors with the largest contributions into the corrosion rate is extracted, based on which reliable corrosion models can be created. Next, a hybrid model generally referred to as ANFIS-PSO (which is based on simulated corrosion experiments) is used to predict corrosion rate of 3C steel. Here, PSO is used as tool for selecting optimal ANFIS parameters accurately. Following with the research, produced prediction errors by the proposed ANFIS- PSO model are compared to those of other models (e.g. ANFIS-GA and SVR). The results will show superior accuracy (with reference to experimental data) of the proposed ANFIS-PSO model over SVR [16] when applied to unseen data.

The rest of this paper is arranged as follows: Section 2 describes the theory of ANFIS and PSO briefly; an introduction on the dataset used in this paper is presented in Section 3; Section 4 gives computational results of the proposed ANFIS-PSO model along with a detailed discussion on the results, with the final conclusions drawn in Section 5.

II. METHOD AND MATERIAL

A. Theory of adaptive neuro-fuzzy inference system (ANFIS)

To determine optimal parameters of Gaussian functions, ANFIS presents a relation for mapping input dataset to output dataset following a hybrid learning approach. As a conventional mathematical tool, ANFIS was first introduced by Jang [17], based on the first-order Sugeno system [18]. ANFIS combines the ideas of Fuzzy Logic (FL) with Neural Network (NN) to form a hybrid intelligent system which is of enhanced automatic learning and adapting capabilities. It represents one of the best trade-offs between (NN) and fuzzy systems, providing smoothness by fuzzy interpolation and adaptability by BPNN [19, 20]. ANFIS networks utilize five layers to create a fuzzy inference system (FIS). Each layer consists of several nodes described by the node function. Inputs into current layers are

outputs from the nodes in preceding layer(s). Fig. 1 shows the inference approach followed by a first-order Sugeno fuzzy model which involves two inputs (x and y) and one output

($f(x, y) = f_{out}$), such that it contains two fuzzy ‘‘if-then’’ rules simply developed as follows:

Rule 1. If x is A_1 and y is B_1 ; then $f_1 = p_1x + q_1y + r_1$.

Rule 2. If x is A_2 and y is B_2 ; then $f_2 = p_2x + q_2y + r_2$.

where A_i and B_i ($i = 1, 2$) are the fuzzy sets corresponding to input membership functions (MFs) x and y , respectively, and p_i , q_i and r_i ($i = 1, 2$) are parameters of the output MFs. The Gaussian MFs of the input parameters x and y are:

$$\mu_{A_i}(x) = \exp\left(-\frac{(x-c_{a_i})^2}{\sigma_{a_i}^2}\right) \quad i = 1, 2 \quad (1)$$

$$\mu_{B_i}(y) = \exp\left(-\frac{(y-c_{b_i})^2}{\sigma_{b_i}^2}\right) \quad i = 1, 2 \quad (2)$$

where $\{c_{a_i}, \sigma_{a_i}\}$ and $\{c_{b_i}, \sigma_{b_i}\}$ are sets of centers and spreads of MFs, respectively. Fig. 2 represents ANFIS structure which is equivalent to the inference process. ANFIS feedforward equations are simply developed as follows:

$$w_i = \mu_{A_i}(x) \mu_{B_i}(y) \quad i = 1, 2 \quad (3)$$

$$\bar{w}_i = \frac{w_i}{w_1 + w_2} \quad i = 1, 2 \quad (4)$$

$$f_{out} = \bar{w}_1 f_1 + \bar{w}_2 f_2 = \frac{w_1}{w_1 + w_2} f_1 + \frac{w_2}{w_1 + w_2} f_2 \quad (5)$$

$$f_{out} = \bar{w}_1 f_1 + \bar{w}_2 f_2 = \frac{w_1}{w_1 + w_2} f_1 + \frac{w_2}{w_1 + w_2} f_2 = \frac{w_1}{w_1 + w_2} (p_1x + q_1y + r_1) + \frac{w_2}{w_1 + w_2} (p_2x + q_2y + r_2) \quad (6)$$

From Fig. 1 and according to Eq. (7), the final output, f_{out} , can be expressed as a linear combination of the corresponding parameters.

$$f_{out} = \bar{w}_1 f_1 + \bar{w}_2 f_2 = \bar{w}_1 (p_1x + q_1y + r_1) + \bar{w}_2 (p_2x + q_2y + r_2) = \bar{w}_1 (p_1x) + \bar{w}_1 (q_1y) + \bar{w}_1 (r_1) + \bar{w}_2 (p_2x) + \bar{w}_2 (q_2y) + \bar{w}_2 (r_2) \quad (7)$$

From Eqs. (1)-(6), it can be seen that, as the performance of ANFIS depends on such parameters as center and spread of each MF, the parameters shall be set appropriately.

ANFIS employs a combination of least-squares and BPNN methods to train MF parameters based on a given training dataset. Formally speaking, such an estimation function is defined as one used to estimate a function $\hat{f} = f_{out}$ in such a way that it can be applied to reasonably approximate the actual function, f . However, the system tends to predict the output y^{\wedge} for a given input vector $(X_1, X_2, X_3, \dots, X_n)$ in such a way that

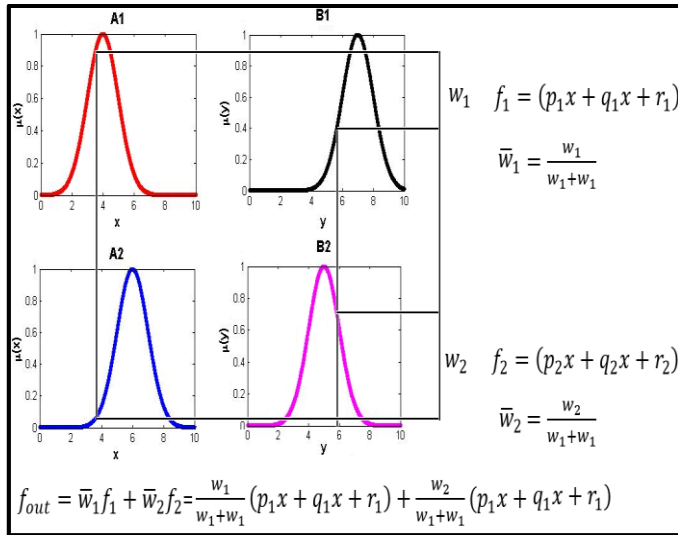

Fig. 1. Inference process of first-order Sugeno.

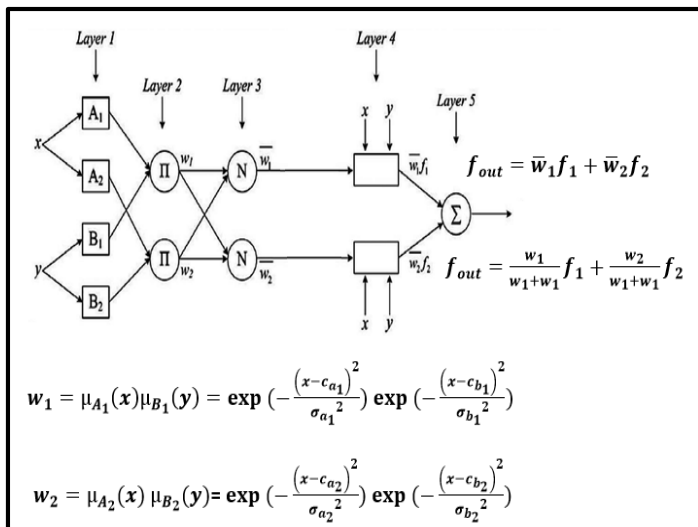

Fig. 2. ANFIS structure.

The ANFIS structure is shown in Fig. 3a. Further, more details of a fuzzy inference system is depicted in Fig. 3b. ANFIS has four major components including a knowledge-based module (which defines the MFs used as the fuzzy rule base) consisting of a set of fuzzy rules and a database. An inference mechanism, that applies the reasoning process to derive outputs of the fuzzification and defuzzification modules while converting the inferred fuzzy sets into crisp output(s), converts crisp inputs into appropriate fuzzy sets.

In its basic form, a FIS consists of a set of fuzzy IF-THEN rules describing input-output pairs.

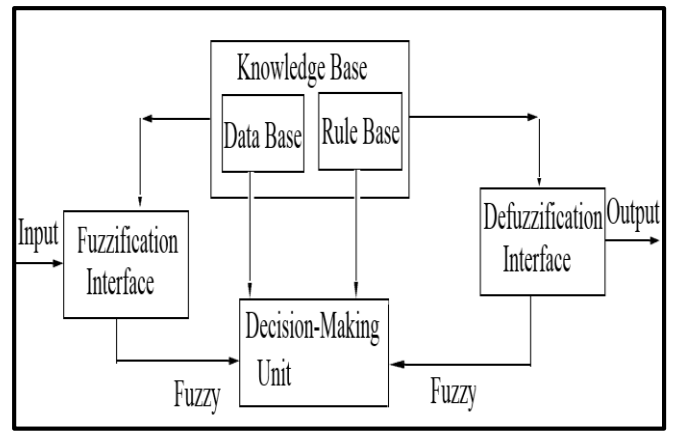

Fig. 3a. ANFIS model structure.

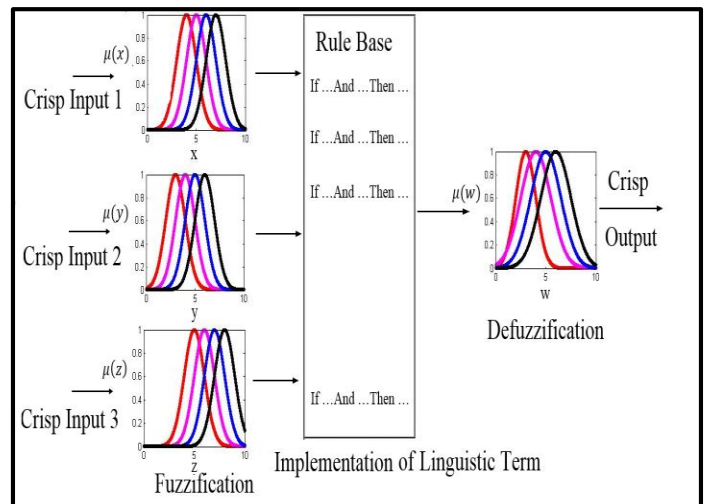

Fig. 3b. Fuzzy inference system diagram.

B. PSO algorithm

Evolutionary algorithms are often used to solve optimization problems in complex, discontinuous, non-linear, and highly constrained search spaces, with no need to neither gradient information nor a comprehensive knowledge of model characteristics, in presence of a wide spectrum of uncertainties. Kennedy and Eberhart [21, 22] introduced PSO as an evolutionary algorithm based on social behavior and swarm intelligence. The main benefit of PSO is that, rather than a single solution, it provides a family of near-optimal solutions with a small variation in performance index. PSO algorithms are based on swarm intelligence which represents a system's ability to get a level of intelligence (i.e. complex behavior patterns) beyond that of other members in the society. However, these complex behavior patterns are created via simple and repetitive tasks performed on each and any member of the society. To find the optimum solution, each particle has its position and velocity information, and hence fitness value, iteratively updated. Behavior of the particles are then altered to improve the probability of having the particles shifted to regions of high fitness value, i.e. meeting optimal solution. Particles can be tuned by tracking their local best values, global best values, present position, and/or velocity information. In PSO, each particle has its particular velocity and position

evolved based on the following equations:

$$v_{id}^{k+1} = w * v_{id}^k + c_1 * r_1^k *(pbest_{id}^k - x_{id}^k) + c_2 * r_2^k *(gbest_d^k - x_{id}^k) \tag{9}$$

$$x_{id}^{k+1} = x_{id}^k + v_{id}^{k+1} \tag{10}$$

In Eqs. (9) and (10), x_{id}^k , x_{id}^{k+1} , v_{id}^k , v_{id}^{k+1} represent the d -dimension values of positions and velocities of the particle i at the k th and $(k + 1)$ th iterations, respectively. $pbest_{id}^k$ represents optimal d -dimension value of the individual i at k th iteration. $gbest_d^k$ is the d -dimension value of the swarm at its most optimal position. Velocities of the particles in different directions are confined between v_{amin} and v_{amax} , so as to avoid particles from getting too far from the state space of the problem. Parameters c_1 and c_2 are referred to as learning factors and normally set to 2. Parameters r_1 and r_2 are random fictions, with their values defined to be randomly fall within [0-1]. In Eq. (9), w represents inertia weight to speed up the rate of convergence which is defined as:

$$w = w_{max} - \left(\frac{w_{max} - w_{min}}{Iter_{max}} \right) * Iter \tag{11}$$

where w_{max} and w_{min} represent maximum and minimum inertia weights, respectively. Also $Iter$ and $Iter_{max}$ stand for current and maximum number of iterations, respectively. PSO resembles other population-based evolutionary algorithms (e.g. differential evolution DE, genetic algorithm GA, etc.) in that it is initialized with random solutions. Subsequently, according to properties of the swarm intelligence and evolution (fitness function), optimal solution is looked for. Each particle is initialized with a random velocity that is then iteratively approached through the state space of the problem toward the best fitness value. The solution evolution process is essentially an iterative process, thereby necessitating a stopping criterion to be met when the learning process is completed. In this research, maximum number of generations is used as the stopping criterion

C. Choosing the best parameters for ANFIS using PSO

A main challenge in optimizing all parameters of ANFIS is different spans within which various parameters should be optimized. In an ANFIS modeling, the values of key parameters can determine the performance of prediction results, as compared to actual values. Training ANFIS parameters presents an optimization problem, so that metaheuristics and evolutionary algorithms can be employed to set ANFIS parameters. In MATLAB implementation of the evolutionary ANFIS training, firstly, a set initial values are generated and considered as ANFIS parameters; these are then optimized by PSO. Performance of an ANFIS model depends on parameters such as center and spread of each membership function $\{c_i, \sigma_i\}$, which should be set appropriately. Actually, ANFIS parameters selection optimizes the search process in the ANFIS model to minimize overall error. As such, in this research, PSO is employed to seek optimal parameters for ANFIS, so as to promote the prediction efficiency. Being directly related to regression performance of ANFIS, root mean square error

(RMSE) was used as fitness function in this paper:

$$RMSE = \sqrt{\frac{1}{n} \sum_{i=1}^n (y_i - \hat{y}_i)^2} \tag{12}$$

where n denotes the number of training samples and y_i and \hat{y}_i represent actually measured and estimated values of the i th training sample. In the present research, 240 parameters were required to be optimized since the case study had six variables (total number of input and output variables) and 20 Gaussian functions, with each Gaussian function having two parameters to be optimized ($6 \times 2 \times 20 = 240$). The parameters of the ANFIS-PSO model for predicting corrosion rate are listed in Table 1.

TABLE 1
ANFIS-PSO PARAMETERS TO PREDICT CORROSION RATE.

PARAMETERS	VALUES
Maximum number of iteration	400
Population size	50
Personal learning coefficient	1
Global learning coefficient	2
Inertia weight damping ratio	0.99
Inertia weight	1
Number of Gaussian functions	20
Number of optimized parameters	240

III. DATASET

Originally compiled in Ref. [23], the dataset used to train and test the proposed ANFIS-PSO model in this study included measured values of 6 variables on 46 samples using an electrochemical technique. Input and output variables and system type are indicated in Fig. 4.

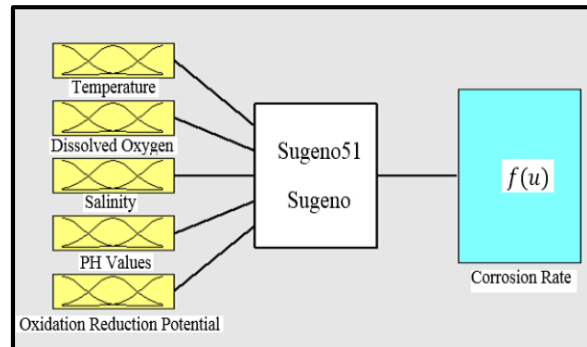

Fig. 4. Input and output variables of ANFIS model.

A. Data preprocessing

Coming from real engineering applications, raw data are usually of unequal ranges. So all data in a dataset need to be preprocessed. The primary purpose of data preprocessing is to simplify calculations and improve efficiency of the model before the ANFIS model is trained. In order to attain this purpose, all data are normalized (mapped) to [-0.5, +0.5]:

$$X_n = \frac{X - X_{min}}{X_{max} - X_{min}} - 0.5 \tag{13}$$

In Eq. (13), X is actual value of the variable under consideration, X_n is normalized value of X , and X_{max} and

X_{min} are the maximum and minimum values of X, respectively.

3.2. Partitioning the dataset

Partitioning the dataset is performed by dividing the whole set of samples into two distinct sets, namely training and testing sets. The training samples are employed to determine the set of optimal parameters for ANFIS model, whereas the testing samples are utilized to demonstrate the model performance in terms of associated prediction errors, and hence the extent to which the model can be generalized. In order to appropriately compare performances of ANFIS-PSO, ANFIS-GA and SVR models, training and testing samples were randomly selected according to Liu et al. [23, 24]. According to the result of Ref. [23], five samples (Samples #7, 10, 14, 19 and 21) were selected as testing data, with the other 41 samples selected as training samples.

3.3. Model evaluation criteria

Model assessment is the main step when it comes to appropriately comparing a model to others. Accordingly, to consider the efficiency of our proposed hybrid model, six criteria (mean square error (MSE), root mean square error (RMSE), correlation coefficients (R2), average percentage relative error (APRE), mean absolute error (MAE) and mean absolute percentage error (MAPE)) were used to evaluate different models' generalizability properties. Table 2 indicates these performance metrics and associated formulae. RMSE and MSE measure the difference between actual and predicted values. R2 is a simple statistical parameter showing how well a model matches corresponding actual data and, consequently, represents a measure of the utility of the model. APRE measures relative deviation from experimental data. MAE and MAPE are used to measure absolute deviation and mean absolute deviation from actual values, respectively. Table 3 indicates these performance indexes and associated calculations, respectively, for the training set, while Table 4 shows the corresponding information to the testing samples.

TABLE 2
PERFORMANCE METRICS AND CALCULATION FORMULA. (a_i, p_i AND \bar{a}_i ARE THE ACTUAL, PREDICTED, AND MEAN OF ACTUAL VALUES, RESPECTIVELY)

Metrics	Calculation formula
MSE	$\frac{1}{n} \sum_{i=1}^n (a_i - p_i)^2$
RMSE	$\sqrt{\frac{1}{n} \sum_{i=1}^n (a_i - p_i)^2}$
R ²	$1 - \frac{\sum_{i=1}^n (a_i - p_i)^2}{\sum_{i=1}^n (p_i - \bar{a}_i)^2}$
APRE	$\frac{1}{n} \sum_{i=1}^n \frac{(a_i - p_i)}{a_i} * 100\%$
MAE	$\frac{1}{n} \sum_{i=1}^n a_i - p_i $
MAPE	$\frac{1}{n} \sum_{i=1}^n \frac{ a_i - p_i }{ a_i } * 100\%$

IV. RESULT AND DISCUSSION

In this research, the ANFIS was applied to construct a predictive model to forecast corrosion rate of 3C steel. Both PSO and GA were used to optimize the ANFIS parameters. MATLAB was employed to compare the proposed ANFIS-PSO model to ANFIS-GA and SVR [16] models. The efficiency of the ANFIS-PSO model was assessed using published datasets for corrosion rate of 3C steel in different seawater environments [23, 24]. Fig. 5 shows a comparison between experimentally measured and predicted corrosion rates by the ANFIS-PSO and ANFIS-GA models when applied on the same testing dataset. Prediction errors are also shown in Fig. 5 where it can be seen that ANFIS-PSO tends to provide lower prediction errors than those of ANFIS-GA. Indeed, PSO appears to provide superior results over GA when it comes to the search for optimal parameters of Gaussian functions. The results illustrate better generalizability of the ANFIS-PSO model rather than ANFIS-GA one, mostly due to the followings. First, unlike GA, PSO does not go through such evolutionary operators as selection, crossover and mutation; in PSO, potential solutions travel through the state space of the problem and this simplifies the implementation process. Second, to find optimal solution, PSO needs just few parameters to be tuned. The major drawback of ANFIS-GA method is that it can be very time-consuming.

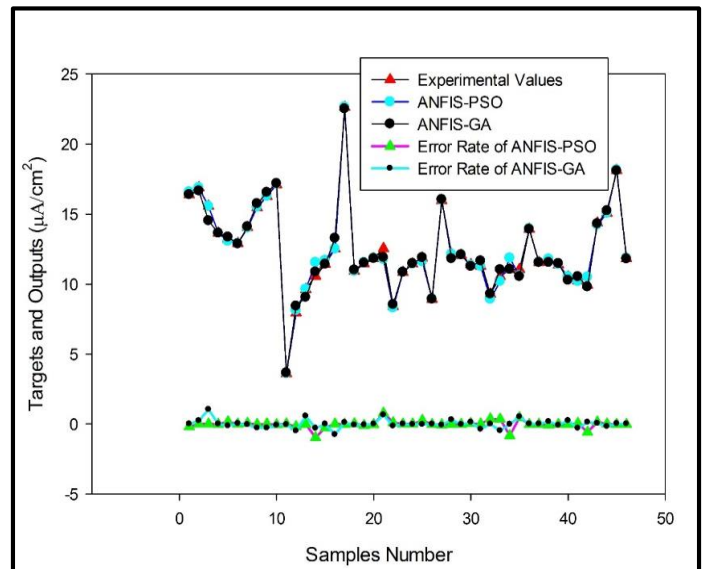

Fig. 5. Comparison between electrochemically measured and predicted values by ANFIS-PSO and ANFIS-GA models.

Fig. 6 illustrates that most of the data points lie either on or very close to the straight-line at the slope of 1. This shows that the predicted corrosion rates by the ANFIS-PSO model are in good agreement with the measured values. Fig. 6 indicates that the proposed hybrid model possesses good interpolation and extrapolation capabilities. From Fig. 7, SVR [16] model is seen to have good interpolation ability; it is further evident that the data point at right-end of the spectrum is seriously deviated from the straight-line, confirming the weak ability of SVR model when it comes to extrapolation; however the hybrid model in this research could overcome the weakness of the SVR model [16].

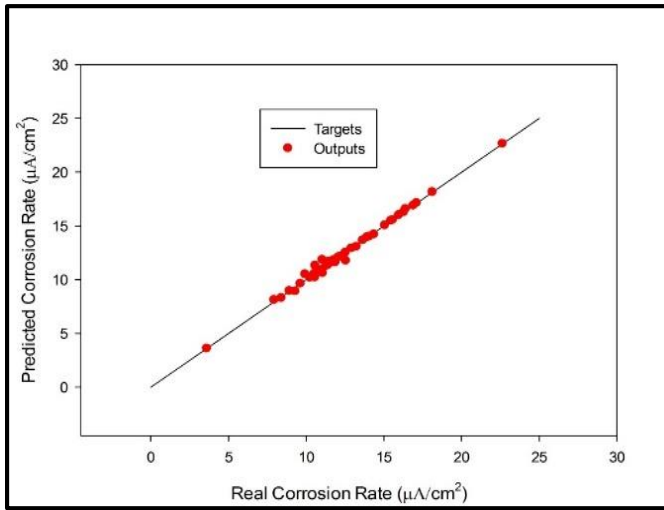

Fig. 6. Actual corrosion rate vs. predicted values by ANFIS-PSO

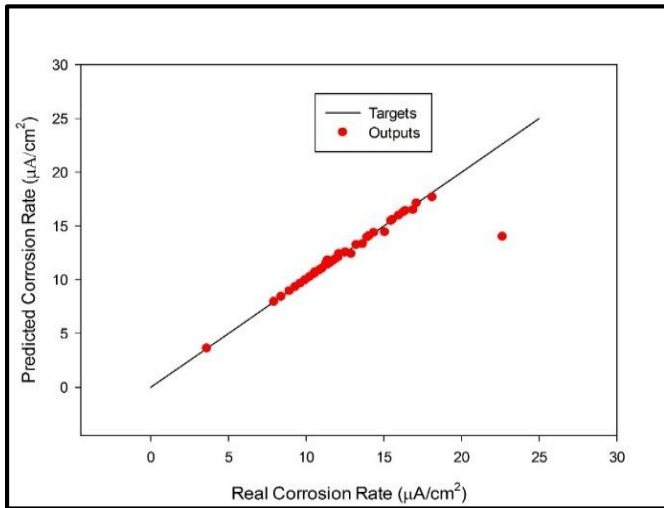

Fig. 7. Real corrosion rate vs. predicted values by SVR [16].

Table 3 compares ANFIS-PSO and ANFIS-GA models based on the obtained values of MSE, RMSE, R^2 , APRE, MAE and MAPE for the same training dataset. Table 3 indicates that, the proposed ANFIS-PSO algorithm outperforms the ANFIS-GA model.

TABLE 3
PERFORMANCE INDEXES AND ASSOCIATED CALCULATIONS
(TRAINING PHASE).

Hybrid model	MSE	RMSE	R^2	APRE	MAE	MAPE
ANFIS-PSO	0.0429	0.2072	0.9958	-0.0742	0.1081	0.9920
ANFIS-GA	0.1094	0.3307	0.9891	-0.0511	0.2118	1.8843

Fig. 8 shows a comparison between experimentally measured and predicted corrosion rates by ANFIS-PSO, ANFIS-GA, and SVR [16] models on the same testing dataset. Testing phase was

implemented to illustrate whether the proposed ANFIS-PSO model is associated with an error any smaller than that of the SVR model [16]. As shown in Fig. 8, when compared to measured values, the results of the ANFIS-PSO model show good precision of this model. Fig. 8 also indicates that ANFIS-PSO outperforms the other two models (SVR [16] and ANFIS-GA) in predicting corrosion rate of 3C steel under different marine environment conditions, when tested on the same testing dataset.

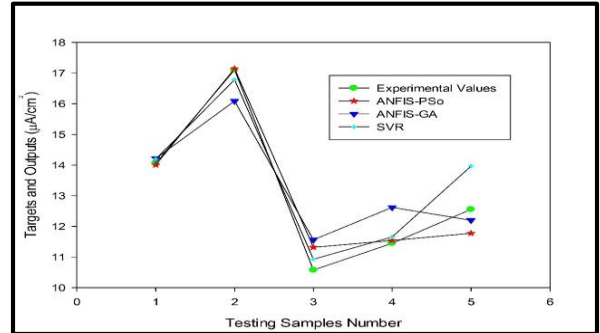

Fig. 8. Comparison between actual and predicted values by ANFIS-PSO, ANFIS-GA, and SVR (testing phase).

Table 4 compares different models on the basis of MSE, RMSE, R^2 , APRE, MAE and MAPE values for the same testing dataset. According to this table, RMSE, R^2 , MAE and MAPE values of the proposed ANFIS-PSO model are superior over those of SVR [16] and ANFIS-GA models, for the same testing dataset.

TABLE 4
PERFORMANCE INDEXES AND ASSOCIATED CALCULATIONS
(TESTING PHASE).

Hybrid model	MSE	RMSE	R^2	APRE	MAE	MAPE
ANFIS-PSO	0.2336	0.4833	0.9525	-0.2828	0.3403	2.9214
ANFIS-GA	0.7087	0.8418	0.7372	-2.3763	0.7384	5.8974
SVR	-----	0.675	0.942	-----	0.485	3.84

V. CONCLUSION

This research aimed at predicting the corrosion rate of 3C steel under the effects of five marine environment factors including temperature, dissolved oxygen, salinity, oxidation–reduction potential, and pH values. For this purpose, PSO algorithm was used to tune optimal parameters for the ANFIS model. Prediction results were compared to those of ANFIS-GA and SVR models. The proposed hybrid model was found to provide smaller prediction errors than those of SVR and ANFIS-GA models, due to not only the use of a combination of neural network with fuzzy logic, but also the advantage of embedding PSO, as an evolutionary algorithm, into ANFIS to converge a globally optimal solution. The PSO appeared to be superior over GA when it came to the optimization of ANFIS parameters. The proposed model for predicting corrosion rate has many advantages over the traditional methods used in the industry, such as empirical, semi-empirical and intelligent models. It has the capability to account for some of essential

factors in seawater environment, which are not considered in SVR and ANFIS-GA models. Comparisons showed that, compared to SVR and ANFIS-GA models, the proposed hybrid model can predict 3C steel corrosion rate more accurately. Finally, the SVR model was found to suffer from limited extrapolation capability, while ANFIS-PSO was seen to be of strong extrapolation capability and generalizability.

REFERENCES

- [1] El-Abbasy, Mohammed S., Ahmed Senouci, Tarek Zayed, Farid Mirahadi, and Laya Parvizsedghy. "Condition prediction models for oil and gas pipelines using regression analysis." *Journal of Construction Engineering and Management* 140, no. 6 (2014): 04014013.
- [2] El-Abbasy, Mohammed S., Ahmed Senouci, Tarek Zayed, Farid Mirahadi, and Laya Parvizsedghy. "Artificial neural network models for predicting condition of offshore oil and gas pipelines." *Automation in Construction* 45 (2014): 50-65.
- [3] Qiu, Xintao, Dongmei Fu, Zhenduo Fu, Kamil Riha, and Radim Burget. "The method for material corrosion modelling and feature selection with SVM-RFE." In *Telecommunications and Signal Processing (TSP), 2011 34th International Conference on*, pp. 443-447. IEEE, 2011.
- [4] J. Liu, H. Wang, Z. Yuan, Forecast model for inner corrosion rate of oil pipeline based on PSO-SVM, *International Journal of Simulation and Process Modelling*, 7 (2012) 74-80.
- [5] Zhang, Wei Dong, Bin Shen, Yi Bo Ai, and Bin Yang. "Gas pipeline corrosion prediction based on modified support vector machine and unequal interval model." In *Applied Mechanics and Materials*, vol. 373, pp. 1987-1994. Trans Tech Publications, 2013.
- [6] Nešić, Srdjan. "Key issues related to modelling of internal corrosion of oil and gas pipelines—A review." *Corrosion science* 49, no. 12 (2007): 4308-4338.
- [7] He, San, Yongli Zou, Desheng Quan, and Hanyi Wang. "Application of RBF neural network and ANFIS on the prediction of corrosion rate of pipeline steel in soil." *Recent advances in computer science and information engineering* (2012): 639-644
- [8] Feliu, S., and M. Morcillo. "The prediction of atmospheric corrosion from meteorological and pollution parameters—I. Annual corrosion." *Corrosion Science* 34, no. 3 (1993): 403-414.
- [9] Senouci, Ahmed, Mohamed Elabbasy, Emad Elwakil, Bassem Abdrabou, and Tarek Zayed. "A model for predicting failure of oil pipelines." *Structure and Infrastructure Engineering* 10, no. 3 (2014): 375-387.
- [10] PAIK, JEOM KEE, ANIL K. THAYAMBALLI, YOUNG IL PARK, AND JOON SUNG HWANG. "A TIME-DEPENDENT CORROSION WASTAGE MODEL FOR SEAWATER BALLAST TANK STRUCTURES OF SHIPS." *CORROSION SCIENCE* 46, no. 2 (2004): 471-486.
- [11] MELCHERS, R. E. "MODELLING IMMERSION CORROSION OF STRUCTURAL STEELS IN NATURAL FRESH AND BRACKISH WATERS." *CORROSION SCIENCE* 48, no. 12 (2006): 4174-4201.
- [12] DÍAZ, VERÓNICA, AND CARLOS LÓPEZ. "DISCOVERING KEY METEOROLOGICAL VARIABLES IN ATMOSPHERIC CORROSION THROUGH AN ARTIFICIAL NEURAL NETWORK MODEL." *CORROSION SCIENCE* 49, no. 3 (2007): 949-962.
- [13] ZHOU, QI, WEI WU, DONGPENG LIU, KAIKAI LI, AND QIAO QIAO. "ESTIMATION OF CORROSION FAILURE LIKELIHOOD OF OIL AND GAS PIPELINE BASED ON FUZZY LOGIC APPROACH." *ENGINEERING FAILURE ANALYSIS* 70 (2016): 48-55
- [14] KHAN, MUHAMMAD MOHSIN, AINUL AKMAR MOKHTAR, AND HILMI HUSSIN. "A NEURAL BASED FUZZY LOGIC MODEL TO DETERMINE CORROSION RATE FOR CARBON STEEL SUBJECT TO CORROSION UNDER INSULATION." IN *APPLIED MECHANICS AND MATERIALS*, VOL. 789, PP. 526-530. TRANS TECH PUBLICATIONS, 2015.
- [15] Ling, Wang, and Fu Dong-Mei. "A novel approach using SVR ensembles for minor prototypes prediction of seawater corrosion rate." In *Computer Science and Engineering, 2009. WCSE'09. Second International Workshop on*, vol. 2, pp. 39-43. IEEE, 2009.
- [16] Wen, Y. F., C. Z. Cai, X. H. Liu, J. F. Pei, X. J. Zhu, and T. T. Xiao. "Corrosion rate prediction of 3C steel under different seawater environment by using support vector regression." *Corrosion Science* 51, no. 2 (2009): 349-355.
- [17] Jang, J-SR. "ANFIS: adaptive-network-based fuzzy inference system." *IEEE transactions on systems, man, and cybernetics* 23, no. 3 (1993): 665-685.
- [18] Takagi, Tomohiro, and Michio Sugeno. "Fuzzy identification of systems and its applications to modeling and control." *IEEE transactions on systems, man, and cybernetics* 1 (1985): 116-132.
- [19] Liu, Yan, Sheng-Li Zhao, and Cheng Yi. "The forecast for corrosion of reinforcing steel based on RBF neural network." In *Wavelet Analysis and Pattern Recognition, 2009. ICWAPR 2009. International Conference on*, pp. 195-199. IEEE, 2009
- [20] Lin, C-T., and C. S. George Lee. "Neural-network-based fuzzy logic control and decision system." *IEEE Transactions on computers* 40, no. 12 (1991): 1320-1336
- [21] Suganthan, Ponnuthurai N. "Particle swarm optimiser with neighbourhood operator." In *Evolutionary Computation, 1999. CEC 99. Proceedings of the 1999 Congress on*, vol. 3, pp. 1958-1962. IEEE, 1999.
- [22] Eberhart, Russell C., Yuhui Shi, and James Kennedy. "Swarm Intelligence (The Morgan Kaufmann Series in Evolutionary Computation)." (2001).
- [23] Liu, Xueqing, Xiao Tang, and Jia Wang. "Correlation between seawater environmental factors and marine corrosion rate using artificial neural network analysis." *Journal of Chinese Society for Corrosion and protection* 25, no. 1 (2009): 11-14
- [24] Liu, Yan-Xia, Xin-Chen Gao, Guo-Ying Zhang, and Huai-hong Guo. "BP neural networks used in prediction and analyses of 3C steel corrosion function." *MATERIALS SCIENCE AND ENGINEERING-HANGZHOU-* 26, no. 1 (2008): 94.