

Enhanced Prognosis of Hybrid Systems with Unknown Mode Changes

Mojtaba Danes¹, Amin Ramezani^{*1}, and Javad Zahedi Moghaddam¹

Abstract— In this paper, a new model for degradation has been introduced to cover multiple dynamics for prognostics purposes. Firstly, Augmented Global Analytical Redundancy Relations (AGARRs) have been introduced to track system's health constantly. Whenever an inconsistency appears, the proposed algorithm checks the Mode Change Signature Matrix (MCSM) and decides if inconsistency is due to a change in modes or an existence of a faulty component. Using Mode Dependent Fault Signature Matrix (MD-FSM), a Set of Candidate Faults will be generated and fed into PF part to estimate the actual fault and parameters of the degradation model. Finally, by applying obtained degradation model, Remaining Useful Lifetime (RUL) will be estimated.

Index Terms— Hybrid Bond Graph; Prognosis; Particle Filter; Remaining Useful Life Tim

I. INTRODUCTION

As the complexity of industrial systems increase, fault diagnosis and failure prognosis become more and more vital since they are critical means to maintain system safety and reliability. Such complex systems, can be modeled as hybrid systems that consist of interacting event-driven and time-driven dynamics. There exist two major issues towards monitoring hybrid systems. The first issue is the method used for modeling the hybrid system such as hybrid automata [1] and hybrid bond graph [2]–[4]. The second issue is simultaneous estimation of continuous and discrete states.

Hybrid Bond Graph (HBG) model is vastly used for model-based fault diagnosis and failure prognosis in literature. The reason is its capability to model incipient faults as well as its ability to model hybrid behavior with switched signals. Regarding model-based fault diagnosis in HBG, [5] proposed a method for offline simultaneous fault diagnosis and mode tracking based on parameterization of unknown mode changes. Assuming there is only one fault, [6] introduced an online method for mode tracking in the presence of fault. However, it cannot be used in multiple fault condition.

Assessing the failure prognosis of hybrid systems and fault diagnosis literatures reveals the fact that prognosis is a more recent concept. Model based failure prognosis of hybrid systems is simply based on formulating mathematical models for faulty components and then, applying a proper estimation tool such as Particle Filter (PF) which will lead to a complete model that describes the faulty parameter evolution in time. Using estimated parameters, the Remaining Useful Life (RUL) will be extrapolated. RUL can be used for Condition Based

Maintenance (CBM) purposes. Having mentioned the above, it is worth to note that there have been a great amount of research towards failure prognosis recently. Reference [7] had a novel look at the prognosis problem in the presence of uncertainty. It had very limiting assumptions where the degradation model is a priori and the system under consideration have to be modeled with continuous form of HBG method called Bond Graph (BG). In [8], the authors have considered the prognosis of HBG model assuming multiple faults which are non-detectable at fault-initiating mode and known mode sequence. Reference [9] has introduced an integrated approach for prognosis of hybrid systems with unknown mode changes in which a Diagnostic Hybrid Bond Graph (DHBG) is used to generate a Set of Candidate Faults (SCF). Then PF enters and refines the real faults and estimates the parameters of fault model for prognosis part. While it seems to be a good solution for prognosis of hybrid systems, it lacks the speed requirements for online implementation due to slow estimation of PF. Therefore it exerts significant delay in RUL determination. In addition, the model used, is considered to be linear or exponential. This assumption has limited the range of systems the algorithm can work with.

This paper is organized as follows: In Section 2, the AGARR-based diagnosis of HBG models are introduced. In addition, DHBG and the algorithm concerning AGARR-based diagnosis and prognosis are presented. Section 3 will be devoted to joint state-parameter estimation via PF. RUL prediction is introduced in Section 4. In Section 5 simulation results will show the performance of the proposed degradation model. Finally, Section 6 will conclude the paper.

I. AGARR-BASED DIAGNOSIS OF HYBRID BOND GRAPH

A. Hybrid Bond Graph

As mentioned in introduction, HBG methodology is vastly used in fault diagnosis and failure prognosis community. HBG provides the opportunity to model several energy domains into a single model and to integrate event-driven dynamics into time-driven dynamics. DHBG is HBG equipped with a special feature [10]. It has a special causality assignment Sequential Causality Assignment Procedure for Hybrid Systems (SCAPH) [11]. Using SCAPH, there will be no requirement to reassign causality of the HBG model after a mode has been changed. In [10], an AGARR is introduced in which mode changes, sensor and actuator faults are included.

B. AGARR Generation

Based on Mode-Dependent Fault Signature Matrix (MD-FSM) it can be seen that, due to probable off switches, some faults might not show any impact on measurements and thus the fault cannot be detected. In other words, MD-FSM shows that in a given mode an individual combination of residuals may or may not be useful for fault diagnosis since they are not isolable. Instead, it generates a set of candidates for faults and feed them to an estimator for accurate parameter estimation.

Regarding mode tracking, Mode Change Signature Matrix (MCSM) is introduced to show the plausibility of an unknown mode change based on residual analysis. If the calculated residual shows an inconsistency then our first guess would be a change in mode. Comparing residuals with MCSM, it can be checked if inconsistency is due to an unknown change in mode or a fault has occurred.

For instance, in Fig. 2. , DHBG model of a two-tank system (Fig. 1.) is presented. AGARRs, MD-FSM and MCSM for $mode = [1\ 0\ 0\ 1]$ are derived as follows

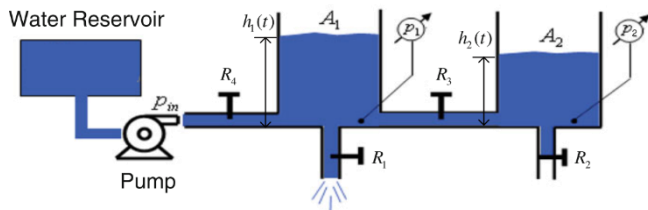

Fig. 1. Two-tank system [6]

$$AGARR_1 = \frac{a_4}{R_4} \left(\beta_{P_m} P_m - \frac{De_1}{\beta_{De_1}} \right) - C_1 \frac{d}{dt} \left(\frac{De_1}{\beta_{De_1}} \right) - \frac{a_1}{R_1} \left(\frac{De_1}{\beta_{De_1}} \right) - \frac{a_3}{R_3} \left(\frac{De_1}{\beta_{De_1}} - \frac{De_2}{\beta_{De_2}} \right) \quad (1)$$

$$AGARR_2 = \frac{a_3}{R_3} \left(\frac{De_1}{\beta_{De_1}} - \frac{De_2}{\beta_{De_2}} \right) - C_2 \frac{d}{dt} \left(\frac{De_2}{\beta_{De_2}} \right) - \frac{a_2}{R_2} \left(\frac{De_2}{\beta_{De_2}} \right)$$

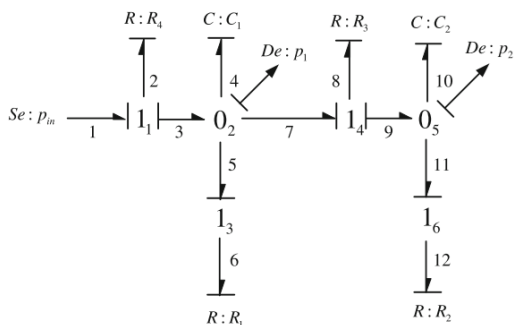

Fig. 2. DHBG model of a two-tank system [6].

TABLE I. MCSM FOR MODE=[1 0 0 1]

Parameters	AGARR 1	AGARR 2	Detectability	Isolability
a_1	1	0	1	0
a_2	0	1	1	1
a_3	1	1	1	1
a_4	1	0	1	0

TABLE II. MD-FSM FOR MODE=[1 0 0 1]

Parameters	AGARR 1	AGARR 2	Detectability
R_1	1	0	1
R_2	0	0	0
R_3	0	0	0
R_4	1	0	1
C_1	1	0	1
C_2	0	1	1
β_{P_m}	1	0	1
β_{De_1}	1	0	1
β_{De_2}	0	1	1

C. AGARR-Based Mode Tracking and Fault Diagnosis

For monitoring purposes, a Coherence Vector (CV) is calculated as $CV = [AGARR_1, AGARR_2]$ [9]. The proposed algorithm works as follows. The CV is constantly under supervision and whenever its entries become non-zero then firstly the algorithm will check MCSM to see whether this inconsistency can be due to an unknown change in modes or not. Then it will calculate AGARRs for all modes. If the algorithm was able to detect a new mode in which CV is consistent, then the system under investigation is healthy and a new mode has been identified. On the other hand, if the algorithm was not able to find a mode in which CV is consistent, there is only one possible explanation for inconsistency and that is a fault. Knowing that the modes have not changed, algorithm checks all the MD-FSM to see which fault might have happened. There is a great possibility that more than one fault have the signature of the calculated CV. In this situation, the algorithm will send all fault candidates to PF in order to estimate the actual values of parameters and find the real fault.

After fault occurrence, the algorithm will not be able to track modes. Therefore, a particle filter will be implemented to track the system states. At this time, the AGARRs will be calculated based on filtered observations while system modes are also modeled as parameters and will be estimated via PF.

In situations where the system is in steady state, the derivation of a signal is equal to zero. Hence, if there is a switch at that part in AGARR, the derivation is multiplied by mode parameters and as a result the change of that mode cannot be detected. Here, a false mode tracking has occurred. Unfortunately, there is no way to detect the actual mode until a known mode change occur. The problem is that this unknown and undetectable change of modes can lead to a poor fault diagnosis and failure prognosis. To overcome the above-

mentioned issue, in addition to monitoring the CV in known modes, other modes are checked while system is in steady state. By doing that, at least we can infer other information about system's mode. As a result, a set of possible modes are generated. In this situation, when an undetectable fault occurs at the new mode, the algorithm will be aware of possible undetectable faults. Since the fault will grow in the new mode, after mode has changed to another trackable mode, the fault will show itself in residuals like a huge step change. [9] has introduced an Auxiliary Residual (AR) to formulize this actions. AR is defined as the derivation of all residuals. Therefore, a step like change in AGARR will lead to a spike in AR.

In Fig. 23, the proposed algorithm has been depicted. For the sake of simplicity, estimation steps are explained in the next sections.

II. PARTICLE FILTER

A. Particle Filter

After obtaining the set of candidates for the faulty parameters, the next part of the algorithm will start to jointly estimate the state and the parameters. For this purpose, PF [12], [13] which is also known as Sequential Monte Carlo (SMC) is used. A degradation model should be applied to enable PF to augment the state estimation with parameter estimation. The major issue is that an accurate degradation model is not available [14]. In our proposed method, a combination of a linear and exponential framework is used to cover linear and nonlinear degradation behaviors.

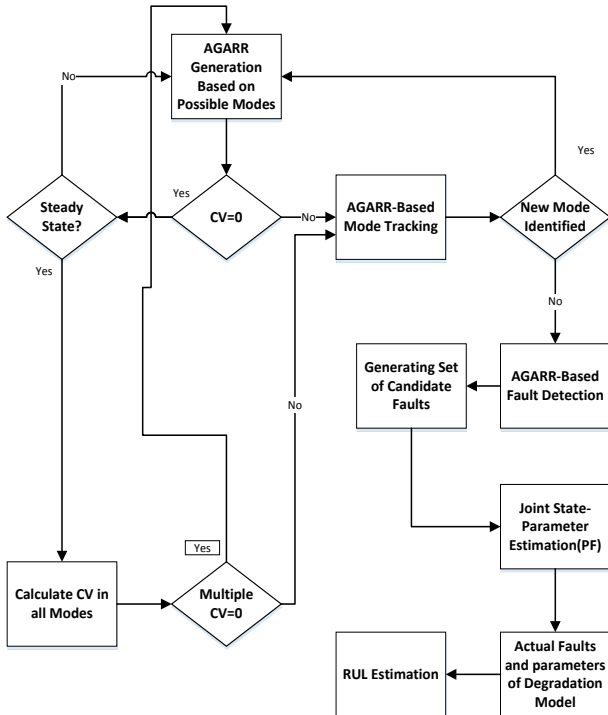

Fig. 3. Schematic of Prognosis framework

$$F_k = \begin{cases} F_0 & k < k_F \\ F^1 \exp(-r^1(k - k_F)T) + F^2(1 - r^2(k - k_F)T) & k \geq k_F \end{cases} \quad (2)$$

In (2), F_k is the faulty parameter, F_0 is the parameter before fault occurrence, k_F is the fault occurrence time, T is the sampling period, r^1 and r^2 are the degradation rates and F^1 and F^2 are coefficients that describe the faulty parameter dynamics. Since there is always a delay between fault occurrence and fault detection in (2), k_F should be changed to k_D .

While Kalman Filter (KF) and its extensions, Unscented Kalman Filter (UKF) and Extended Kalman Filter (EKF), are known for state estimation in linear systems and non-linear systems with additive Gaussian noise, PF has the ability to handle non-linear systems with non-Gaussian noises. Recently, this tool has been used for prognosis of engineering systems [15].

System dynamics can be modeled as:

$$\begin{aligned} x_k &= f_k(x_{k-1}, v_{k-1}) \\ y_k &= h_k(x_k, n_k) \end{aligned} \quad (3)$$

For each fault candidate, there are three parameters that describe the degradation dynamics. Therefore, we augment the state vector with these parameters. $[r^1, r^2, F^1, F^2]$. In other words, for a SCF $\in \mathbb{R}^m$, the new augmented state will be of order \mathbb{R}^{n+4m} and is defined as follows:

$$z = [x \ F^1 \ F^2 \ r^1 \ r^2] \quad (4)$$

It is worth to note that, the dynamics of the degradation parameters is random walk. For instance, for F^1 :

$$F_k^1 = F_{k-1}^1 + \sigma_k^1 \quad (5)$$

where σ_k^1 is random noise with the pdf shown in Fig. 4.

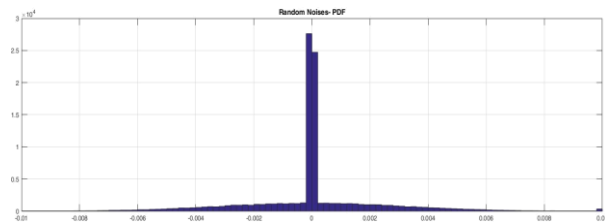

Fig. 4. Random Noise used in random walk.

The augmented model will be like:

$$\begin{aligned} z_k &= \bar{f}_k(z_{k-1}, v_{k-1}) \\ y_k &= h_k(z_k, n_k) \end{aligned} \quad (6)$$

Preparing the augmented model, it is time to use PF for joint state-parameter estimation. PF consists of two steps: prediction and update. In prediction, using state model the prior pdf of states are obtained. Then, having new measurements, PF updates the results. PF uses the idea of weighted particles.

$$p(z_k | y_{1:k}) = \sum_{i=1}^N w_k^i \delta(z_k - z_k^i) \quad (7)$$

where z_k^i is a set of independent random particles from $p(z_k | y_{1:k})$, N is the total number of particles, w_k^i is the weight of i th particle at time k . Since, in practice $p(z_k | y_{1:k})$ is usually unknown; here, importance sampling is utilized to sample z_k^i from an arbitrary chosen distribution $q(z_k^i | z_{k-1}^i, y_k)$ called importance-density function. Thus, the weights are given by:

$$\omega_k^i = \omega_{k-1}^i \frac{p(y_k | z_k^i) p(z_k^i | z_{k-1}^i)}{q(z_k^i | z_{k-1}^i, y_k)} \quad (8)$$

The weights are normalized by:

$$\omega_k^i = \frac{\omega_k^i}{\sum_{l=1}^N \omega_k^l} \quad (9)$$

If the importance density function is chosen as [12]

$$q(z_k^i | z_{k-1}^i, y_k) = p(z_k^i | z_{k-1}^i) \quad (10)$$

Then the update stage will be as follows:

$$\omega_k^i = \omega_{k-1}^i p(y_k | z_k^i) \quad (11)$$

A common problem with this kind of PF is the degeneracy phenomenon, where after a few iterations, all but one particle will have negligible weights. It has been shown that the variance of the importance weights can only increase over time, and thus, it is impossible to avoid the degeneracy phenomenon. This degeneracy implies that a large computational effort is devoted to updating particles whose contribution to the approximation of $p(x_k | z_{1:k})$ is almost zero. A practical approach for estimating the effective sample size \hat{N}_{eff} is introduced in [12].

$$\hat{N}_{eff} = \frac{1}{\sum_{i=1}^{N_s} (\omega_k^i)^2} \quad (12)$$

One of the methods by which the effects of degeneracy can be reduced is to use resampling whenever a significant degeneracy is observed. Here, we have used the systematic resampling [12].

I. PARTICLE FILTER-BASED PROGNOSTICS AND RUL PREDICTION

After running the PF, the resulted particles are used to predict RUL. Each particle will propagate forward until it reaches its End Of Lifetime (EOL). Therefore the m -step prediction of each particle will be computed as follows:

$$F_{k+m}^i = F_{k_D}^{1,i} \exp(-r_{k_D}^{1,i} (k+m-k_D)T) + F_{k_D}^{2,i} (1-r_{k_D}^{2,i} (k+m-k_D)T) \quad (13)$$

Since the weights of particles in propagation stage remains constant at ω_k^i , the expectation could be computed as:

$$E(F_{k+m}) = \sum_{i=1}^{N_s} \omega_k^i F_{k+m}^i \quad (14)$$

If we define a failure threshold F_{th} , the EOL of each particle can be obtained by solving the following equation:

$$F_{th} = F_{k_D}^{1,i} \exp(-r_{k_D}^{1,i} (k+T_{EOL}^i - k_D)T) + F_{k_D}^{2,i} (F_{k_D} - r_{k_D}^{2,i} (k+T_{EOL}^i - k_D)T) \quad (15)$$

The pdf of T_{EOL} shows the statistical distribution of RUL. In addition the expected value of RUL can be calculated by:

$$E\{RUL\} = \sum_{i=1}^{N_s} \omega_k^i T_{EOL}^i \quad (16)$$

II. SIMULATION

In this section, another example of DHBG system, Fig. 5. Fig. 6. is adopted from [9] to show the performance of the algorithm.

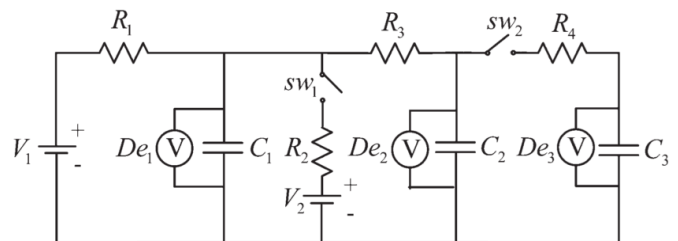

Fig. 5. Electric Circuit with hybrid dynamic[9]

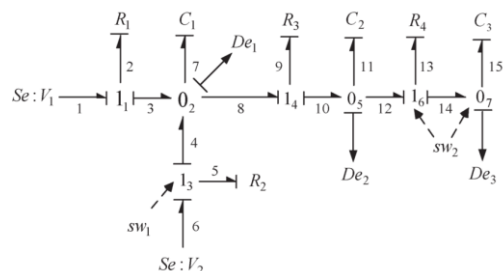

Fig. 6. DHBG of Electric Circuit[9]

AGARRs can be calculated as follows:

$$G_1 = \frac{1}{R_1} (\beta_{V_1} \cdot V_1 - \frac{De_1}{\beta_{De_1}}) + \frac{a_1}{R_2} (\beta_{V_2} \cdot V_2 - \frac{De_1}{\beta_{De_1}}) - C_1 \frac{d}{dt} (\frac{De_1}{\beta_{De_1}}) - \frac{1}{R_3} (\frac{De_1}{\beta_{De_1}} - \frac{De_2}{\beta_{De_2}})$$

$$G_2 = \frac{1}{R_3} (\frac{De_1}{\beta_{De_1}} - \frac{De_2}{\beta_{De_2}}) - C_2 \frac{d}{dt} (\frac{De_2}{\beta_{De_2}}) - \frac{a_2}{R_4} (\frac{De_2}{\beta_{De_2}} - \frac{De_1}{\beta_{De_1}})$$

$$G_3 = a_2 \left[\frac{1}{R_4} (\frac{De_2}{\beta_{De_2}} - \frac{De_{13}}{\beta_{De_3}}) - C_3 \frac{d}{dt} (\frac{De_3}{\beta_{De_3}}) \right]$$

The circuit in Fig. 6. has two switches. Hence, there are four different modes each one represented with an array with binary entries. For instance, [0 1] stands for the mode in which first switch is open and the second switch is closed.

The nominal parameters are:

An exponential incipient fault at 1020 step has been inserted to C_2 when the system is at $mode = [0 0]$ to show the performance of the algorithm. The second residual will act as Fig. 7. , other residuals are below the threshold. Then CV will change to = [0 1 0] . MCSM (TABLE III.) will be used to decide whether the inconsistency is due to a change in mode or not. Since CV is inconsistent with MCSM, the change should be due to a fault in parameters.

TABLE III. MCSM

CJ	G_1	G_1	G_1	Detectability	Isolability
$sw_1(a_1)$	1	0	0	1	1
$sw_2(a_2)$	0	1	1	1	1

Now based on MD-FSM in = [0 0] TABLE IV. , a set of candidate faults have been identified by the algorithm including $C_2, \beta_{De1}, \beta_{De2}, R_3$. PF has to refine the correct faults and also estimate degradation parameters. Therefore an augmented model is created with 19 state.

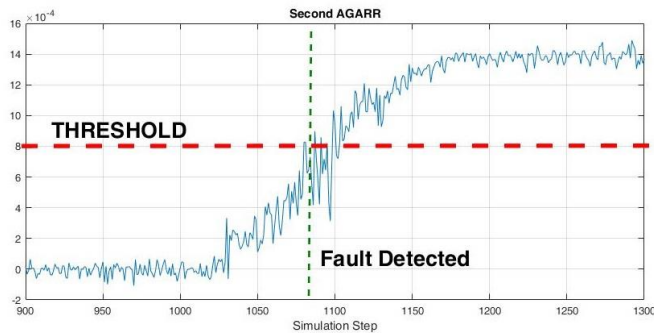

Fig. 7. Second AGARR

It is worth to note that, noise is a challenging problem here since there is derivatives in AGARR generations which intrinsically boosts the noise. To handle the problem we used a low-pass filter to eliminate the derivation of a noisy signal.

The value of the threshold is chosen by observing residual responses under a system-healthy condition. It is worth noting that threshold should be carefully set to avoid false alarm. To deal with measurement noise a low-pass filter is adopted.

Fig. 8. illustrates the estimated states of the system at fault occurrence. Estimated parameters of degradation model for each candidate fault were used to find the estimated value of estimated fault. If the estimated value was near the nominal value, then we can infer that it was not the true fault and vice versa. The real fault's corresponding particles are used to calculate RUL . Fig. 9. shows the RUL distribution.

TABLE IV. MD-FSM ([0 0])

	G_1	G_2	G_3	Detectability
β_{De1}	1	1	0	1
β_{De2}	1	1	0	1
β_{De3}	0	0	0	0
β_{V_1}	1	0	0	1
β_{V_2}	0	0	0	0
R_1	1	0	0	1
R_2	0	0	0	0
R_3	1	1	0	1
R_4	0	0	0	0
C_1	1	0	0	1
C_2	0	1	0	1
C_3	0	0	0	0

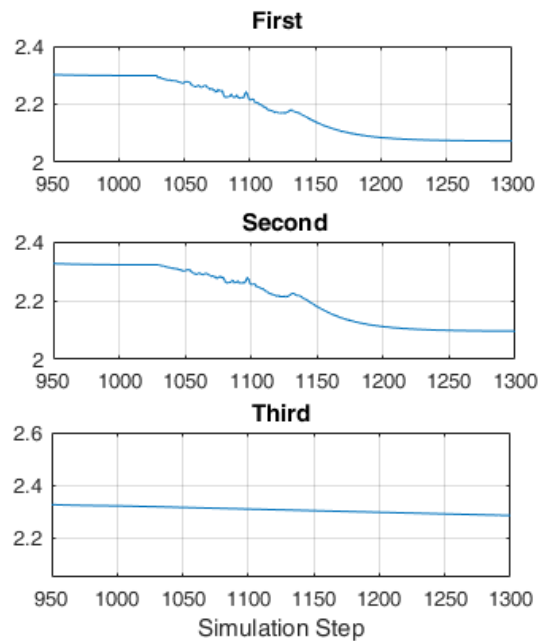

Fig. 8. Estimated States

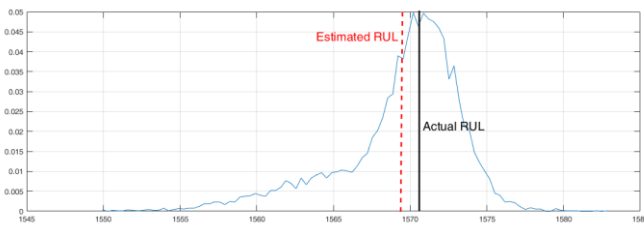

Fig. 9. Estimated RUL Distribution

III. CONCLUSION

In this paper after introducing AGARR-based fault diagnosis and mode tracking, we proposed a new model for degradation behavior for prognosis. Since the proposed model has the ability to handle linear and exponential dynamics, it could be beneficial for prognostic purposes where a flexible dynamic is needed. The model and PF were able to estimate true fault correctly and extract RUL in an acceptable manner. Our model however, has a negative side. In our approach, the uncertainty in model was not taken into account which has a significant effect on results. In our future works, we will deal with uncertainty in model to increase the performance of the algorithm.

IV. REFERENCES

- [1] O. Azzabi, C. Ben Njima, and H. Messaoud, "Diagnosis of a dynamic hybrid system by hybrid timed automata," in *2016 International Conference on Control, Decision and Information Technologies (CoDIT)*, pp. 618–623, 2016.
- [2] Y. Ming, "Fault Diagnosis and Prognosis of Hybrid Systems using Bond Graph Models and Computational Intelligence," 2012.
- [3] W. Borutzky, *Bond Graph Model-based Fault Diagnosis of Hybrid Systems*. Springer, 2015.
- [4] Y. Wu, Y. Wang, Y. Jiang, and Q. Sun, "Multiple parametric faults diagnosis for power electronic circuits based on hybrid bond graph and genetic algorithm," vol. 92, pp. 365–381, 2016.
- [5] M. Yu, D. Wang, M. Luo, D. Zhang, and Q. Chen, "Fault detection, isolation and identification for hybrid systems with unknown mode changes and fault patterns," *Expert Syst. Appl.*, vol. 39, no. 11, pp. 9955–9965, 2012.
- [6] D. Wang, M. Yu, C. B. Low, and S. Arogeti, *Model-based Health Monitoring of Hybrid Systems*. 2013.
- [7] M. S. Jha, G. Dauphin-Tanguy, and B. Ould-Bouamama, "Particle filter based hybrid prognostics for health monitoring of uncertain systems in bond graph framework," *Mech. Syst. Signal Process.*, pp. 1–29, 2016.
- [8] M. Yu, D. Wang, M. Luo, and L. Huang, "Prognosis of hybrid systems with multiple incipient faults: Augmented global analytical redundancy relations approach," *IEEE Trans. Syst. Man, Cybern. Part A Systems Humans*, vol. 41, no. 3, pp. 540–551, 2011.
- [9] M. Yu, D. Wang, and M. Luo, "An Integrated Approach to Prognosis of Hybrid Systems With Unknown Mode Changes," *IEEE Trans. Ind. Electron.*, vol. 62, no. 1, pp. 503–515, 2015.
- [10] C. B. Low, D. Wang, S. Arogeti, and M. Luo, "Quantitative hybrid bond graph-based fault detection and isolation," *IEEE Trans. Autom. Sci. Eng.*, vol. 7, no. 3, pp. 558–569, 2010.
- [11] C. B. Low, D. Wang, S. Arogeti, and J. B. Zhang, "Causality assignment and model approximation for hybrid bond graph: Fault diagnosis perspectives," *IEEE Trans. Autom. Sci. Eng.*, vol. 7, no. 3, pp. 570–580, 2010.
- [12] M. S. Arulampalam, S. Maskell, N. Gordon, and T. Clapp, "A tutorial on particle filters for online nonlinear/non-Gaussian Bayesian tracking," *IEEE Trans. Signal Process.*, vol. 50, no. 2, pp. 174–188, 2002.

[13] A. Doucet and A. Johansen, "A tutorial on particle filtering and smoothing: fifteen years later," *Handb. Nonlinear Filter.*, no. December, pp. 656–704, 2011.

[14] M. Jouin, R. Gouriveau, D. Hissel, M. C. Péra, and N. Zerhouni, "Particle filter-based prognostics: Review, discussion and perspectives," *Mech. Syst. Signal Process.*, vol. 72–73, pp. 2–31, 2016.

[15] M. Jha, G. Dauphin-tanguy, and M. D. Hissel, "Particle Filter Based Prognostics of PEM Fuel Cell Under Constant Load," vol. 6, no. 2, 2016.