

Design and evaluation of offline/online controller for series hybrid electric vehicles

Behzad Zabihi *, Seyed Mohammad Ali Mohammadi and Adib Barshan

Abstract_ This study is aimed at designing offline and online controller for energy management of series hybrid electric vehicles (SHEV). Where besides decreasing fuel consumption and keeping BATTERY state of charge within acceptable range, reduces air pollution. In this paper two energy management strategies of SHEV are designed. In first strategy based on known driving cycle, a fuzzy logic controller (FLC) is designed to control power of Electric battery (EB) and internal combustion engine (ICE). In the second control strategy, width of Gaussian membership functions in FLCs of first strategy are optimized. Preliminarily optimization of Gaussian membership functions widths is done by ant colony optimization (ACO) algorithm, then according to four representative driving cycles, four optimized FLCs are designed. In contrast with first strategy the four FLCs can control and manage power of EB and ICM for an unknown driving cycle. Recognition of deriving cycle is based on features extraction of each driving cycle. A learning vector quantization (LVQ) neural network is used to recognized pattern of unknown driving cycle. Finally after recognition of driving cycle, driving cycle recognition (DCR) network algorithm is used to manage switching between optimized FLCs. To verify performance and efficiency of proposed method simulation performed due to Matlab/Advisor environment.

Keywords— Series Hybrid Electric vehicle (SHEV), Energy Management, Fuzzy Logic controller (FLC), Ant colony optimization, Driving cycle, Pattern recognition

I. INTRODUCTION

Today's growing oil price and environmental protection made automotive industry to focus on economic vehicles with low air pollution and high performance [1]. Automotive industry is aiming at developing new generation of vehicles to reduce dependency on fossil fuels without sacrificing vehicle performance [2, 3]. Thus Hybrid electric vehicles (HEVs) based on hybrid technology seems to be the most economical solution so far [3].

HEVs are generally known as vehicles with two types of energy sources, internal combustion engine (ICE) and electric Battery (EB). Three main structures for hybrid drivetrains are series, parallel and series-parallel structure. In series hybrid electric vehicle (SHEV) a generator first convert mechanical output of engine to electricity. Converted electricity is used to charge battery or propel the wheel via electric motor and mechanical transmission [4, 5]. Fig 1 shows the four operating modes needed to illustrate power flow control in SHEVs. During start up, acceleration or normal driving, both power sources deliver electrical energy to power converter by

generator. At light load since engine output is greater than required for mechanical power, generated electrical energy is used to charge battery. During barking and deceleration, Electric motor (EM) works as generator and kinetic energy of wheels is transformed to electricity, hence battery is charged via power converter [5].

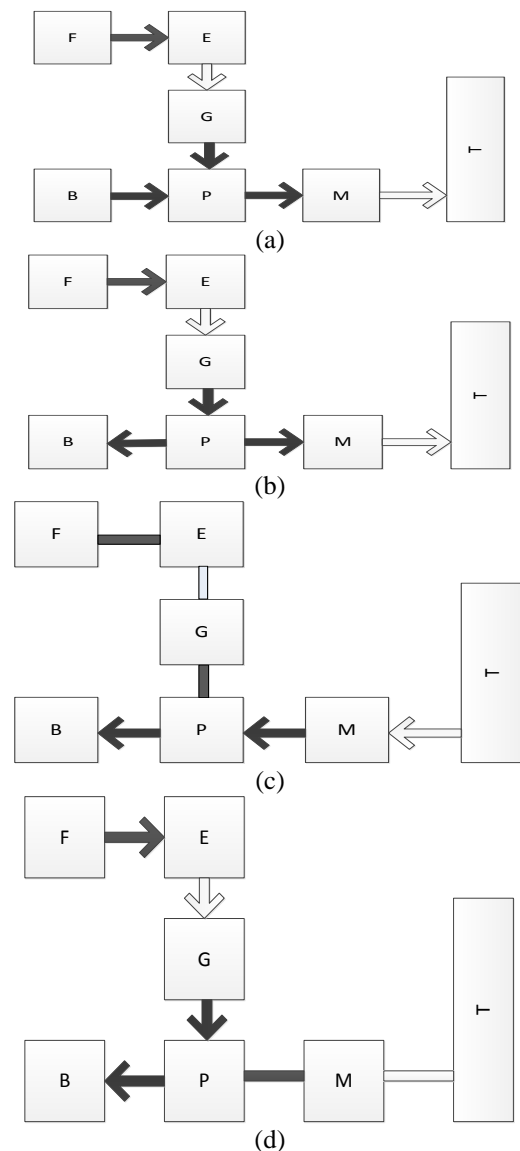

Fig.1. Series Hybrid operating modes (a) startup/ normal driving/ acceleration (b) light load (c) deceleration/ braking (d) Battery charging [3]

Manuscript received February 18, 2017; October 9, 2017
 MSc student of control engineering, faculty of electrical engineering, Shahid Bahonar University, Kerman, Iran (email: behzadzabihi1991@gmail.com), Phone number: 03431322715
 Assistant professor, faculty of electrical engineering, Shahid Bahonar University, Kerman, Iran.

PhD student of control Engineering, faculty of electrical engineering, Shahid Bahonar University, Kerman, Iran

B: Battery, E: Engine, F: Fuel tank, G: Generator, M: Electric Motor, P: Power convertor, T: Transmission system
 ■ Electrical Link — Hydraulic Link = Mechanical link.

Because of power flow control for both mechanical and electrical path, Coordination between energy sources in HEVs is the main challenge. Many control approaches have been proposed to manage energy between EB and ICE [6]. The main proposed approaches to the energy management problem and control power sources in HEVs are rule based energy management and optimization based control strategies [7].

Control rules in Rule based control strategies are designed based on intuition and expertise of designer. Deterministic and fuzzy rule based methods are the main classification of rule based strategies. Nonlinear dynamic, parameter sensitivity to ambient factors, load complexity and uncertainty of system made the fuzzy based control methods to be the hot direction in HEVs [8, 9]. Different control strategies have been proposed to control and manage power sources in HEVs. Antonio Piccolo et al, proposed an energy management methodology that starts from desired vehicle on road performance. Genetic algorithm is employed to identify value of the energy flows management parameters that minimize a cost function descriptive of the design objectives in terms of fuel consumption and emissions [10]. John T.B.A Kessels et al, proposed an online energy management strategy that can mimic optimal solution without using a priori road information. Instead of solving a mathematical optimization problem, the methodology concentrates on a physical explanation about when to produce, consume, and store electric power [11]. In research by Vanessa Paladini et al, numerical optimization of vehicle configuration and control strategy of the hybrid electric vehicle is introduced. Optimization is carried out with multi objective genetic algorithm and the goal of optimization is to reduce fuel consumption [12]. This paper is organized as follows; section 2 discusses pattern recognition of unknown driving cycle and consists of feature extraction, DCR network structure and simulation results of pattern recognition procedure. First proposed control strategy is explained in section 3. Section 4 provides discussion about second control strategy that can control power sources of HEVs for an unknown driving cycle. Finally in section 5 simulation results of both control strategies are discussed.

II. PATTERN RECOGNITION OF UNKNOWN DRIVING CYCLE

Pattern recognition of driving cycle can be divided to three steps:

- 1) Features extraction: in this step large number of features in driving cycle are measured to be classified later.
- 2) Feature selection: in first step large number of features have been extracted. But generally it is emphasized to have low number of features [13]. Because of large number and correlation of features, principal component analysis (PCA) method has been used to reduce dimension of feature space [14].
- 3) Classification of patterns: in this step selected features are applied to a classifier structure. According to the features of

input, this structure determines the most similarity between input and one of the classes. Hence the input is belonged to the most similar class according to common features. Similarity level is usually measured by a distance criterion. For example hamming distance, Euclidean distance, and square distance are most common criterions. Classification is almost done according to a set of input features that is called feature vector. Classification methods are divided in to two parts: numerical and non-numerical. Numerical method is based on deterministic and statistical measurement in geometric space. Non-numerical method is based on sing processing by fuzzy approach, genetic algorithm and some other algorithms [15, 16].

In HEVS driving cycles play great role in fuel economic and air pollution. In the next part, driving cycle recognition by drive cycle recognition (DCR) algorithm is explained that is based on LVQ neural network.

A. Feature extraction from driving cycle

In this part DCR algorithm is used to assign unknown driving cycles in to four standard determined driving cycles. Fig 2 shows mechanism of DCR algorithm. The four standard driving cycles are shown in Fig 3. Name, type and class number of the four standard driving cycles are listed in table 1.

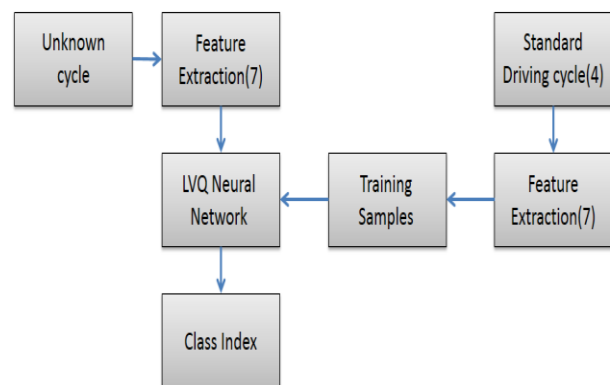

Fig.2. Mechanism of DCR algorithm

Each driving pattern mainly depends on traffic load of city, road type and road condition [14, 16]. In this study for pattern recognition, four standard driving cycles:

- CYC New York Bus
- CYC-INDIA URBAN-SAMPLE
- CYC-Nuremberg R36
- CYC-SCO3

Are used, which include all road types and conditions

TABLE1
 NAME, TYPE AND CLASS NUMBER OF THE FOUR STANDARD DRIVING CYCLES

Type of drive cycle	Drive cycle name	Drive cycle Number
SnG road	CYC-NewYorkBus	1
Urban road	CYC-Nuemberg R36	2
Suburb road	CYC-INDIA - URBAN-SAMPLE	3
Highway road	CYC-SCO3	4

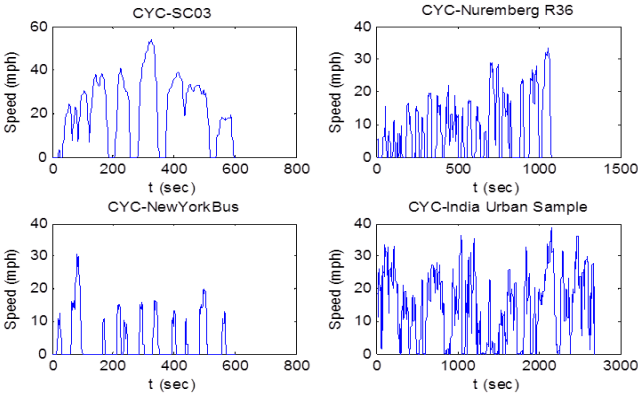

Fig3: Four representative driving cycles

To recognize pattern of driving cycles the seven selected features are as follows.

- Maximum speed (V_{max})
- Average speed (V_{avg})
- Maximum acceleration (a_{max})
- Maximum deceleration (dec_{max})
- Average acceleration (a_{avg})
- speed standard deviation (V_{std})
- percentage of idle time ($Idle\ percent$)

$$V_{Max} = \max(V(t_{cur}), V(t_{cur} - \Delta t), \dots, V(t_{cur} - (n - 1) \cdot \Delta t)) \quad (1)$$

$$V_{avg} = \frac{\int_0^{t_{cur}} v(t) dt - \int_0^{t_{cur} - \Delta w} v(t) dt}{\Delta w} \quad (2)$$

$$a_{Max} = \max(a(t_{cur}), a(t_{cur} - \Delta t), \dots, a(t_{cur} - (n - 1) \cdot \Delta t)) \quad (3)$$

$$dec_{Max} = \min(a(t_{cur}), a(t_{cur} - \Delta t), \dots, a(t_{cur} - (n - 1) \cdot \Delta t)) \quad (4)$$

$$a_{avg} = \frac{\int_0^{t_{cur}} a(t) \cdot (a(t) > 0) dt - \int_0^{t_{cur} - \Delta w} a(t) \cdot (a(t) > 0) dt}{\Delta w} \quad (5)$$

$$V_{Std} = \sqrt{\frac{\sum_{i=0}^{n-1} (V_i - V_{avg})^2}{n}} \quad (6)$$

$$Idle_percent = \frac{\sum_{i=0}^{n-1} [V(t_{cur}) - i \cdot \Delta t] < eps}{n} * 100 \quad (7)$$

In Fig 4 recognition period is shown, $\Delta\omega$ is recognition cycle and Δt is prediction period. In fact extracted features of unknown driving cycle are measured by experimental methods. In this study due to the absence of measurement tools, data are calculated via equations (1) to (7). Since feature extraction from huge amount of data is time consuming, recognition period is divided in to equal time intervals, since $t_{cur} \cdot \Delta\omega = \Delta t$ represents current time. In Fig 5 extracted features of CYC-CSHVR driving cycle resultant of related equations are shown.

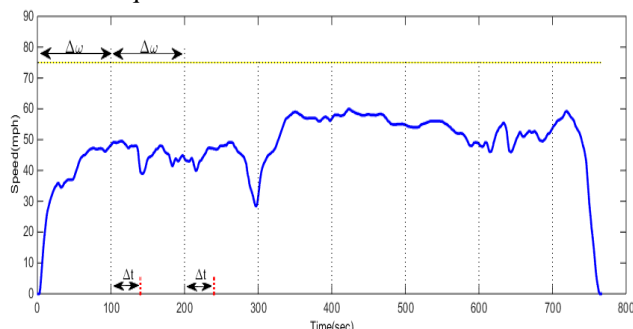

Fig.4.Period of driving cycle recognition

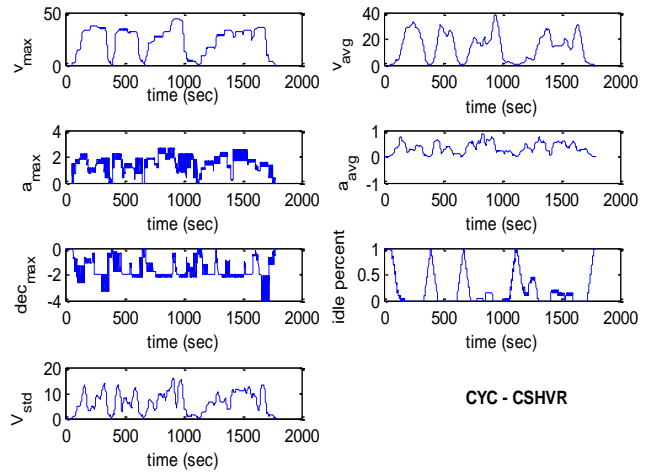

Fig5. Extracted features of CYC-CSHVR driving cycle

B. DCR network structure

In this part an LVQ neural network is used as classifier set. LVQ is supervised version of SOM neural network introduced by Kohonen [17]. Simplicity of this neural network make it a popular solution for recognition and identification of patterns in control systems.

Structure of LVQ network is shown in Fig 6. Where I, O, C are input layer, output layer and competitive layer respectively, also H represents neurons. Features vector is defined as $X = [X_1, X_2, \dots, X_7]$ and is applied to input layer. ω_{ij} Shows weight between i th neuron and j th neuron. In competitive layer the winner is a layer with smallest Euclidian norm and most similar to one of the four representative classes. The winner layer is coded by binary value of 1 and other layers are 0. Therefore four driving cycles are coded 0001,0010,0100,1000 respectively and winner layer is considered as output of neural network.

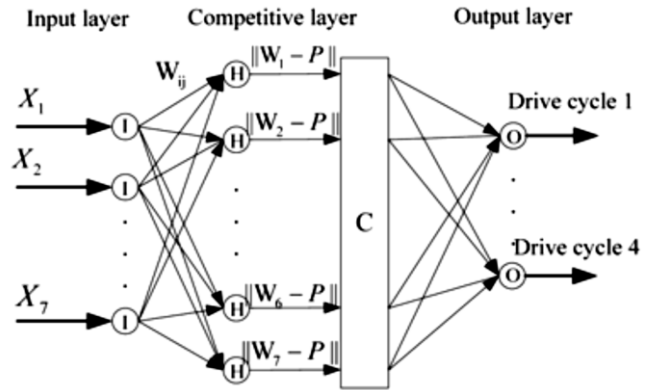

Fig6. LVQ neural network structure

For designing LVQ neural network, seventy percent, fifteen percent and fifteen percent of the four selected driving cycle's data are used respectively to train, evaluate and test of neural network. In this study input of neural network is a vector consist of seven features of unknown driving cycle, where is resultant of equations (1) to (7). In Fig 7 the interaction matrixes of training, evaluation and test data are shown. Interaction matrix shows that ninety percent of data are classified correctly and this fact confirms a correct classification. The target and neural network output are shown in Fig 8.

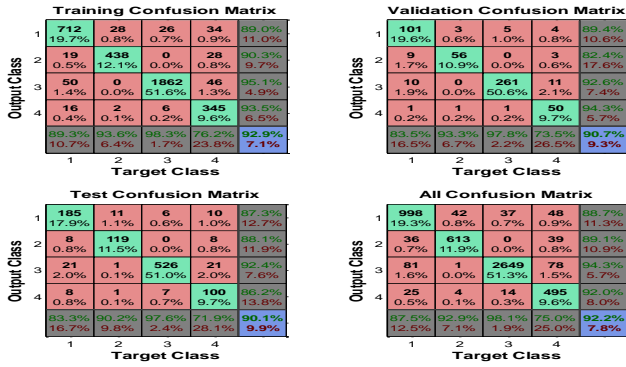

Fig7. Interaction matrixes

C. Simulation

In this part DCR network is used to classify driving cycles of CYC- WVUSUB. The seven features of each unknown cycle is extracted via equations (1) to (7). According to the features of unknown driving cycle, LVQ network recognizes the class which each part of cycle is belonged to. Classification procedure of unknown driving cycle to the four representative cycles is shown in Fig 9.

III. FIRST PROPOSED CONTROL STRATEGY

Since energy management is important in HEVs, therefore a fuzzy logic controller is designed to control power and energy between energy sources. Characteristics of studied SHEV in this research are listed in table 2. In first proposed control strategy a designed Mamdani type fuzzy logic controller (FLC) is used. In this strategy driving cycle is considered to be known so that Performance of proposed FLC as an offline controller is compared with default controller of Advisor software. In Fig 10 and 11, box of vehicle model and Structure of fuzzy controller are shown respectively. Since FLC is not based on precise mathematical model, requested power from ICE is lower.

TABLE2
CHARACTERISTICS OF STUDIED SHEV

Components	Parameters	Values
Engine	Maximum power	41 kw
	Peak efficiency	0.34
Energy Storage (Battery)	Capacity	12 Ah
	Normal coltage	184 V
Motor	Maximum power	75 kw
	Peak efficiency	0.92
Generator	Maximum power	75 kw
	Peak efficiency	0.95
Vehicle	Drive type	Front-wheel drive
	Mass	1373 kg

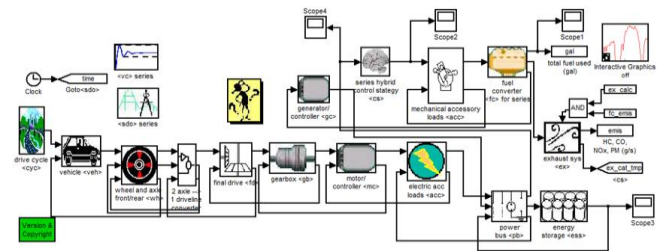

Fig10. Box of vehicle model in Advisor

Two inputs of fuzzy logic controller are the chain of hybrid power (P1) and state of charge (SOC). In Fig 12 to 14 membership functions of first input, second input and output of FLC are shown respectively

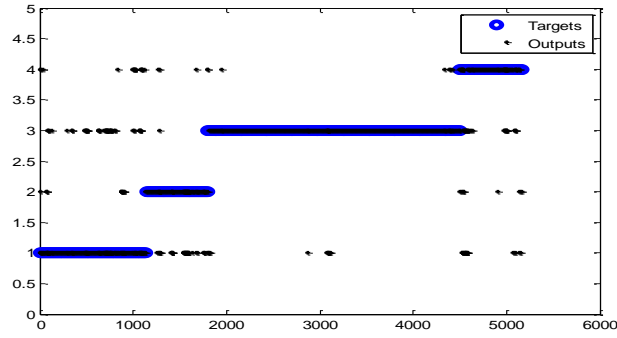

Fig8. Target and neural network output

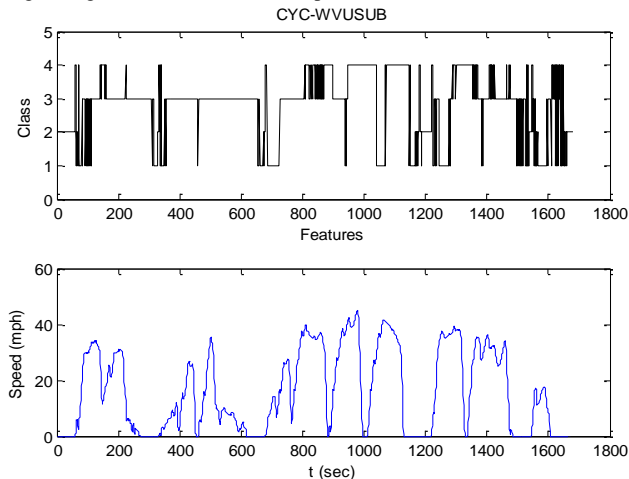

Fig9. Classification of Unknown driving cycle

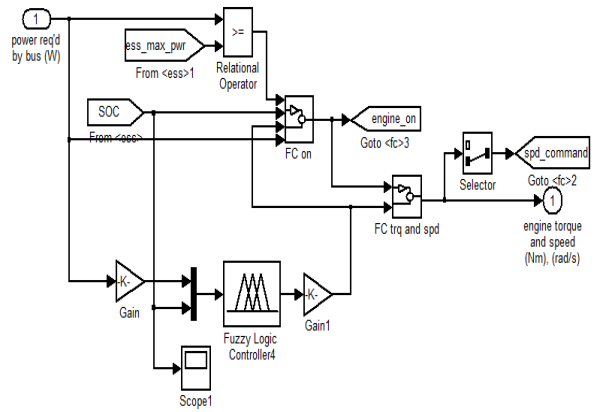

Fig11. Structure of proposed FLC

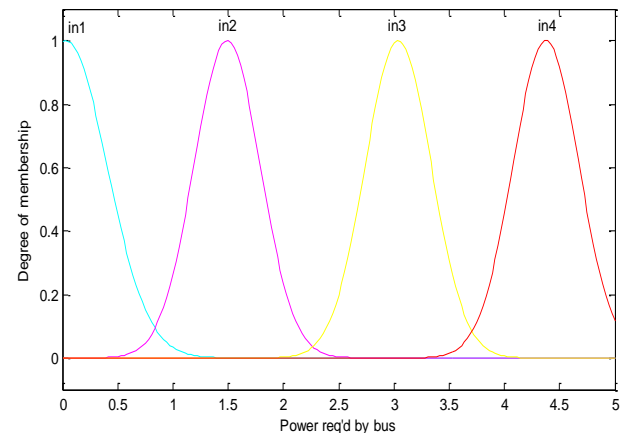

Fig 12. First input of FLC, P1

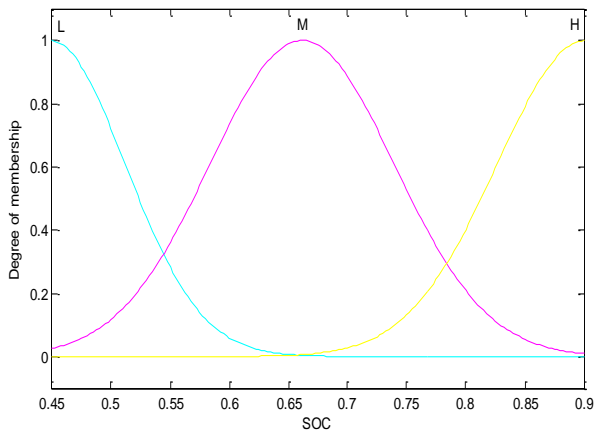

Fig 13. Second input of FLC, SOC

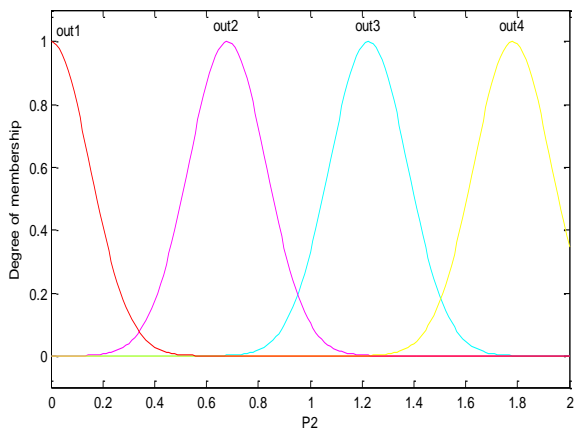

Fig 14. Output of FLC

IV. SECOND PROPOSED CONTROL STRATEGY

In first control strategy of SHEV, data of known driving cycle were used. In this part since driving cycle is considered to be unknown, in order to manage power sources of HEV, online controller is proposed. Second control strategy is consist of three parts.

A. **Optimization:** to reduce air pollution and also keeping SOC within acceptable range at the end of driving cycle, performance of controller is optimized by continues ant colony optimization (ACO) algorithm.

B. **Pattern recognition and classification:** classification of different driving cycles is done by proposed LVQ neural network.

C. **Neural fuzzy controller:** in this part by combining results of the last two parts, a sub optimal FLC controller is designed.

Optimization:To optimize performance of first proposed FLC, Continues ACO algorithm is used which leads to reducing air pollution and also keeping SOC within acceptable rang. To perform optimization, target function and tuning parameters are defined and specified. Equation 8 defines Target function

$$J(x)_{x \in X} = \sqrt{1/N \sum_{i=1}^N \Delta SOC_i^2 + w \times FC} \tag{8}$$

Where X is parameter optimization space, N is number of samples, W is weight of fuel consumption and FC represents amount of fuel consumption in driving cycle period according to one liter per 100 kilometer. Also ΔSOC_i is defined as below

$$\Delta SOC_i = \Delta SOC_i - 0.7 \tag{9}$$

The cost function J is in fact is a weighted summation of fuel consumption and SOC changes. At the end of driving cycle, minimization of cost function leads to minimum changes of SOC and fuel consumption. The value of weight W is considered properly to highlight importance of fuel consumption and SOC. In this study W is equal to 0.02. Width of input and output Gaussian membership functions are considered as optimization parameters. In first proposed control strategy for POWER REQ'D BY BUS as first input and SOC as the second input, four and three Gaussian membership functions used respectively. Also four membership functions are used for the output P2 and total optimization parameters are eleven. In order to design sub optimal energy management strategy based on pattern recognition, it is necessary to classify unknown driving cycle by LVQ neural network. Then an optimal FLC is used in that class. Hence according to the four representative driving cycles that explained before, four FLCs are needed. Optimization of FLCs is done by continues ACO algorithm and table 3 shows optimization parameters.

TABLE3
CHARACTERISTIC OF CONTINUES ACO ALGORITHM

Maximum iteration	60
Population size	10
Selection pressure	0.5
Difference rate - distance	1

Fig 15 to 18 show the optimal membership functions and target functions of representative driving cycles after optimization process.

Designing sub optimal Neural-fuzzy controller:In this part a Neural-fuzzy energy management based on pattern recognition by LVQ neural network is presented. The proposed controller is combination of optimal fuzzy controller and LVQ neural network. Since driving cycle is unknown, the data are applied to LVQ neural network and then are classified to four classes based on four representative driving cycles. After recognition of driving cycle the related designed optimal FLC start energy managing of SHEV. In Fig 19 structure of second proposed control strategy is shown. In the next part performance of controller is evaluated by a simulation example.

CYC-India Urban Sample

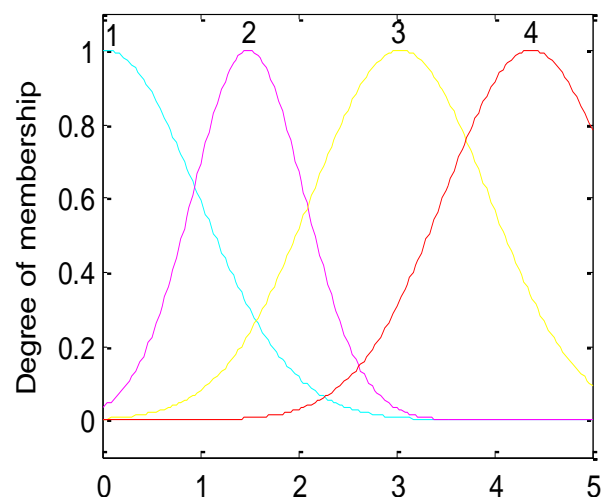

Fig 15. First input of sub optimal FLC

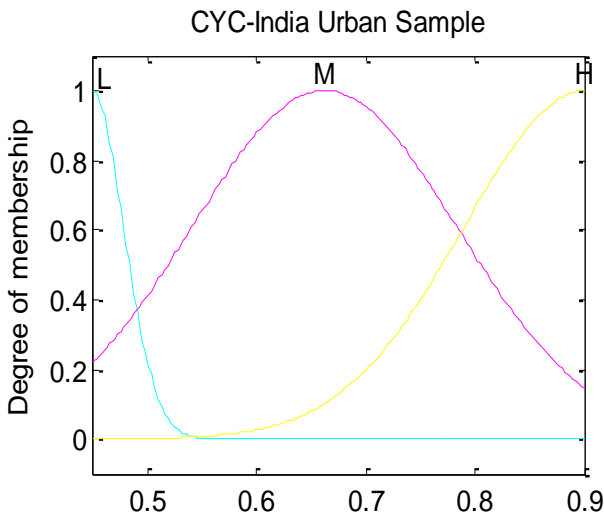

Fig.16. Second input of sub optimal FLC

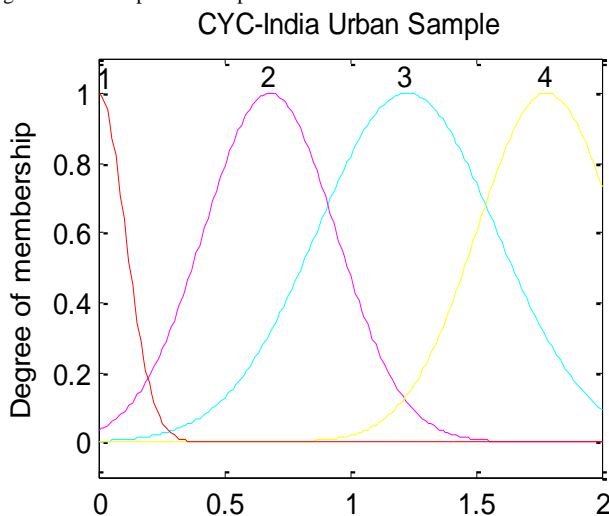

Fig.17. Output of sub optimal FLC

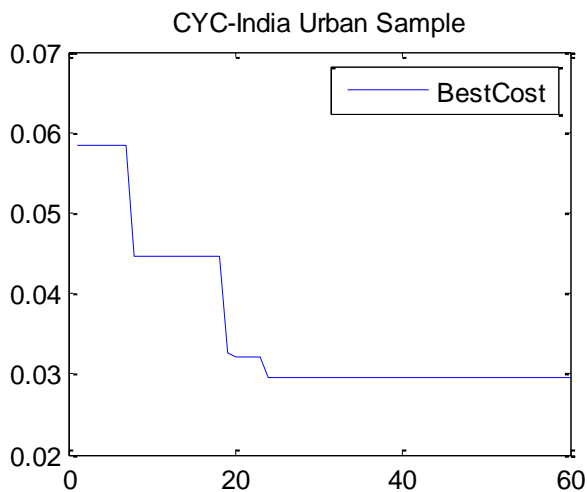

Fig.18. Target Function of representative driving cycle

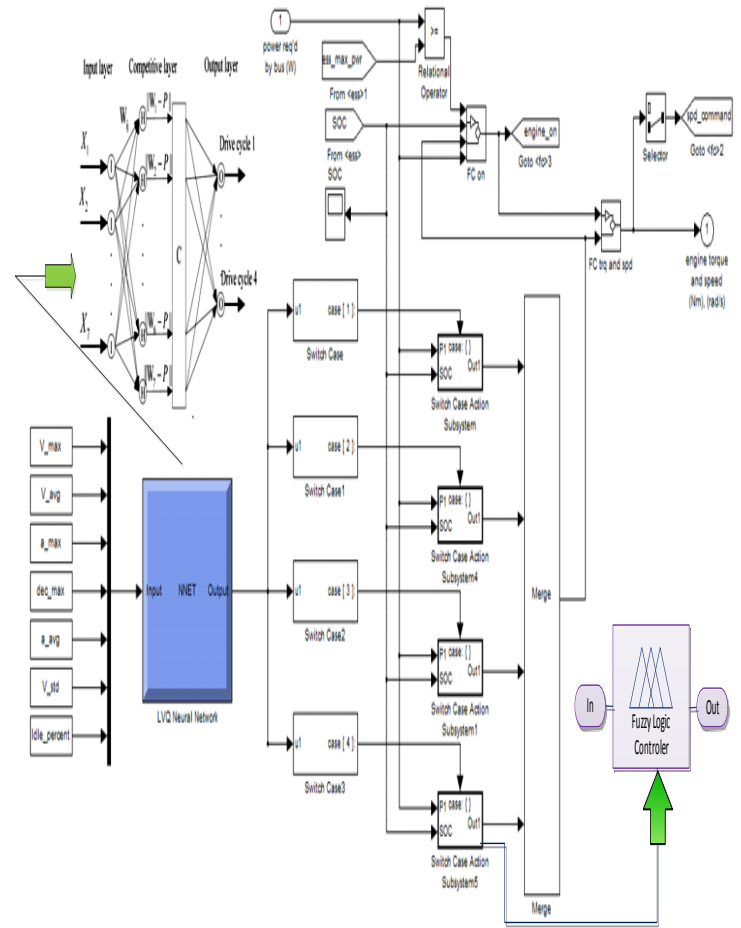

Fig.19. Structure of second proposed control strategy

V. SIMULATION

In this part performance of proposed Neural- Fuzzy controller on reducing fuel consumption, air pollution and also keeping SOC within acceptable range, is simulated. First the features of CYC- HL07 driving cycle as unknown driving cycle are extracted. Feature vector as input is applied to LVQ neural network. After pattern recognition and classification, the designed optimal Neural-Fuzzy controller of that class is switch on to control energy sources of SHEV.

A. Controller effect on fuel consumption

In Fig 20 effect of default Advisor software controller, first proposed FLC and proposed Neural-Fuzzy controller on fuel consumption are shown. It is clear that total fuel consumption curve of Neural-Fuzzy controller is below of other curves. This fact shows better performance of neural-fuzzy controller on reducing fuel consumption.

B. Controller effect on pollutants emission

HC pollutant:In Fig 21 effect of default Advisor software controller, first proposed FLC and proposed Neural-Fuzzy controller on HC pollutant emission is shown. The results of simulation are listed in table 4 and show that neural-fuzzy controller has better effect on HC pollutant emission. Second control strategy decreases HC pollutant emission 85% and 75% better than advisor software default controller and first FLC respectively.

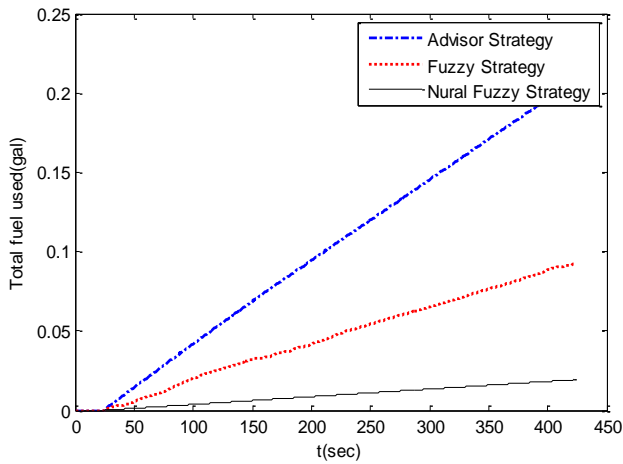

Fig.20. Controller effect on fuel consumption

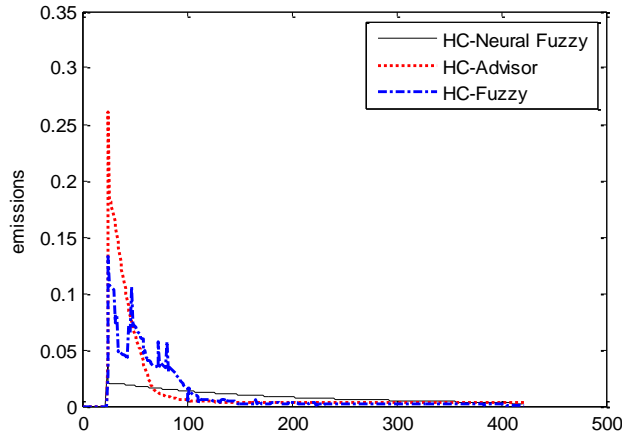

Fig.21. Controller effect on HC pollutant emission

CO pollutant: Fig 22 shows the effect of default Advisor software controller, first proposed FLC and proposed Neural-Fuzzy controller on emission of CO pollutant. The results of simulation are listed in table 5. The results show that neural-fuzzy controller has better effect on CO pollutant emission. Second proposed control strategy decreases CO pollutant emission 94% and 82% better than Advisor software default controller and first FLC, respectively.

Nox pollutant: In Fig 23 effect of default Advisor software controller, first proposed FLC and proposed Neural-Fuzzy controller on emission of Nox pollutant is shown. The results of simulation are listed in table 6, and it is clear that neural-fuzzy controller has better effect on Nox pollutant emission. Hence second proposed control strategy decreases Nox pollutant emission 97% and 95% better than advisor software default controller and first FLC, respectively.

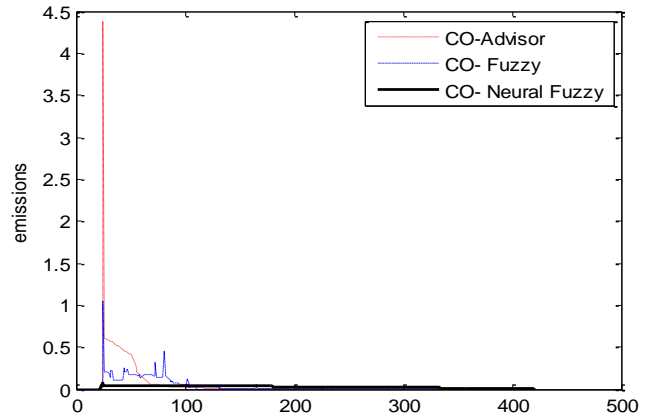

Fig.22. Controller effect on CO pollutant emission

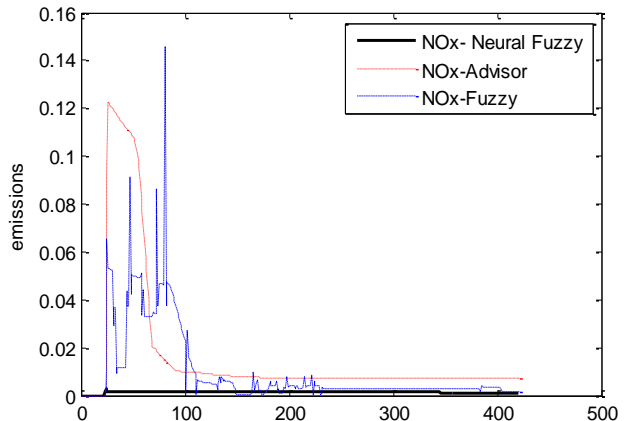

Fig23. Controller effect on NOx pollutant emission

Controller effect on SOC: Fig 24 shows the effect of default Advisor software controller, first proposed FLC and proposed Neural-Fuzzy controller on SOC. According to simulation results, SOC at the end of driving cycle is kept within acceptable range by all three controllers. Since structure of Neural fuzzy controller is based on pattern recognition of unknown driving cycle, classification and switching of optimal designed FLCs. Therefore neural fuzzy controller kept SOC within the best range.

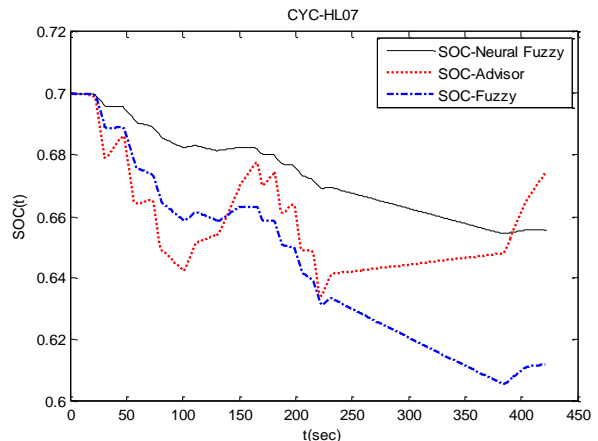

Fig. 24. Controller effect on SOC

TABLE 4
CONTROLLER EFFECT ON HC POLLUTANT EMISSION

Controller type	Area under the curve Hc	Hc (grams/mile)
Advisor default controller	1.0216	2.25
FLC of first strategy	0.6132	1.354
neural-fuzzy controller	0.1387	0.352

TABLE5:
CONTROLLER EFFECT ON CO POLLUTANT EMISSION

Controller type	Area under the curve Co	Co (grams/mile)
Advisor default controller	6.91	15.179
FLC of first strategy	1.98	4.38
neural-fuzzy controller	0.3	0.762

TABLE 6
CONTROLLER EFFECT ON NOX POLLUTANT EMISSION

Controller type	Area under the curve NOx	NOx (grams/mile)
Advisor default controller	0.5904	1.3
FLC of first strategy	0.3022	0.667
neural-fuzzy controller	0.0116	0.03

VI. CONCLUSION

In this study two control strategy for energy management of SHEV are studied. In first control strategy a fuzzy logic controller, as an offline controller is designed and replaced with default Advisor software controller. Simulation results show that proposed controller has better performance on reducing fuel consumption, air pollution and keeping battery charge level within acceptable range. The second proposed strategy is focused on unknown driving cycle where in the first strategy it is assumed that driving cycle is known. Therefore in second control strategy a designed LVQ neural network is used for pattern recognition of driving cycle, and DCR algorithm classifies unknown driving cycle to four representative cycles. For each representative cycles an optimal FLC is designed which optimization of FLCs is done by continues ACO algorithm. Finally after identification of driving cycle class, the FLC of identified class is switch on to control energy management of SHEV. In comparison with first strategy second proposed controller is more complex and 0.358 sec slower than first one. But simulation results show better performance of proposed controller than other controllers of SHEVs. The last proposed control strategy is simulated for SEKELTON driving cycle. The results show that neural fuzzy controller has the best performance on reducing fuel consumption, air pollution and keeping battery charge level within acceptable range than other controllers.

REFERENCES

- [1] F. Yan, J. Wang, and K. Huang, "Hybrid Electric Vehicle Model Predictive Control Torque-Split Strategy Incorporating Engine Transient Characteristics," *IEEE Transaction on Vehicular Technology*, Vol. 61, No. 6, July 2012.
- [2] J.S. Martinez, R.I John, D. Hissel, M.C. Pera, "A survey based type-2 fuzzy Logic system for energy management in hybrid electrical vehicle," *Information Sciences*. Vol. 190, pp. 192-207, May 2012.
- [3] A.Behzadpour, H. Eliasi "Fuzzy Based controller Design for Parallel Hybrid Electric Vehicle," International Conference on Knowledge-Based Engineering and Innovation, Tehran, Iran, November, 2015.
- [4] S. Overington, S. Rajakaruna, "Review of PHEV and HEV Operation and Control Research for Future Direction," 3rd IEEE International Symposium on Power Electronics for Distributed Generation Systems, Aalborg, Denmark, June 2012.
- [5] K.T. Chau, Y.S. Wong "Overview of power management in hybrid electric vehicles," *Energy Conversion and Management*, Vol. 43, pp. 1953-1968, 2002.
- [6] F. R Salmasi, "Control Strategies for hybrid electric: Evolution, Classification, Comparison and Future Trends," *IEEE Transaction on Vehicular Technology*, Vol. 56, pp. 2393-2404, No. 5, sept 2007.
- [7] L. Serrao et al. "Open Issues in Supervisory Control of Hybrid Electric Vehicles: A Unified Approach Using Optimal Control Methods" *Oil & Gas Science and Technology – Rev. IFP Energies nouvelles*, Vol. 68, No. 1, pp. 3-178, 2013.
- [8] Sh. Xu, "Investigation of EMS based on fuzzy logic controller for an ICE/battery/UC hybrid electric vehicle," 2nd International Conference on Artificial Intelligence, Management Science and Electronic Commerce, Dengleng, China, 2011.
- [9] W. Yifeng, Z. Yun, W. Jian, Ch. Ning, "Energy management system based on fuzzy control approach for hybrid electric vehicle," *Conference on Control and Decision (CCDC), China, 2009*.
- [10] A. Piccolo, L. Ippolito, V.Galdi, A.Vaccaro, "Optimization of Energy Flow Management in Hybrid Electric Vehicle via Genetic Algorithms," *IEEE/ASME International conference on Advanced Intelligent Mechatronics Proceedings, Italy, July 2001*.
- [11] John T. B. A. Kessels et al, "Online Energy Management for Hybrid Electric Vehicles", *IEEE Transaction on Vehicular Technology*, Vol. 57, No. 6, pp.3428-3440, Nov 2008.
- [12] V. Paladini, T. Donateo, A. de Risi, "Super Capacitor Fuel Cell Hybrid Electric Vehicle Optimization and Control Strategy Development," *Energy Conversion and Management*, Vol. 48, pp.3001-3008, 2007.
- [13] S. il Jeon et al, "Multi-mode driving control of a parallel hybrid electric vehicle using driving pattern recognition," *Dynamic system measurement and control*, Vol. 124, pp. 141-149, 2002.